

CONVENTIONAL FIRE PANELS

J424



J408



INSTALLATION MANUAL



This Control panel can be programmed using the respective Software **J400** release 1.1 or higher.

BENTEL SECURITYsrl shall not assume the responsibility for damage arising from improper application or use.

This Control panel has been designed and manufactured to the highest standards of quality and performance.

Installation of this Control panel must be carried out strictly in accordance with the instructions described in this manual, and in compliance with the local laws and bylaws in force

The **J424** and **J408** Control panels comply with the essential requirements of standards **EN54-2; EN54-4; EN12094-1.**

EN12094-1 certification shall be deemed void if the J400-EXT Extinguishment Module is not installed in the Control panel.

BENTEL SECURITY srl reserves the right to change the technical specifications of these products without prior notice.

	
0051	
BENTEL SECURITY s.r.l. Via Gabbiano, 22 - Zona Ind. S. Scolastica 64013 Corropoli (TE) - ITALY	
09	
0051-CPD-0197 (J400-EXT in J424) 0051-CPD-0196 (J400-EXT in J408-2/J408-4/J408-8)	
EN12094-1 Electrical automatic control and delay device	
Environmental class A Protection level IP30 Flooding zones 1 to 4 CO2, inert gas, halogenate hydrocarbon Expected Options: <ul style="list-style-type: none">- Delay of extinguishing signal- Monitoring of status of components- Emergency hold device- Control of flooding time	
Response delay activated condition:	maximum 3 s
Response delay triggering of outputs:	maximum 1 s

	
0051	
BENTEL SECURITY s.r.l. Via Gabbiano, 22 - Zona Ind. S. Scolastica 64013 Corropoli (TE) - ITALY	
09	
0051 - CPD - 0192 (J408-2) 0051 - CPD - 0193 (J408-4) 0051 - CPD - 0194 (J408-8) 0051 - CPD - 0195 (J424)	
EN 54-2:1997+A1:2006 Control and indicating equipment for fire detection and fire alarm systems for buildings.	
EXPECTED OPTIONS Dependencies on more than one alarm signal: type C Delays to outputs Test condition Output to fire alarm devices Output to fire alarm routing equipment	

Recycling information

BENTEL SECURITY recommends that customers dispose of their used equipments (panels, detectors, sirens, and other devices) in an environmentally sound manner. Potential methods include reuse of parts or whole products and recycling of products, components, and/or materials.

For specific information see:

www.bentelsecurity.com/en/environment.htm

Waste Electrical and Electronic Equipment (WEEE) Directive



In the European Union, this label indicates that this product should NOT be disposed of with household waste. It should be deposited at an appropriate facility to enable recovery and recycling.

For specific information see:

www.bentelsecurity.com/en/environment.htm

INTRODUCTION	5	INSTALLING THE CONTROL PANEL	21
The J424 and J408 Control panels	5	Installing accessory boards	21
<i>Accessory Items</i>	5	<i>Installing Extinguishment Modules</i>	21
Description	5	<i>Installing Expander Module Kit (for J424 ONLY)</i>	22
<i>Inputs</i>	5	<i>Display Module (for J424 and J400-REP ONLY)</i>	24
<i>Outputs</i>	6	Installing Repeaters	25
<i>Operating features</i>	6	Installing the Control panel	25
<i>Interface</i>	7	Description of the Terminals	25
<i>Extinguishment Module</i>	8	<i>Main Board and Expander Board terminals</i>	25
<i>Access to Signalling and Commands</i>	8	<i>Main Board Terminals</i>	26
<i>Power Supply</i>	8	<i>Extinguishment Module Terminals</i>	28
<hr/>		The System Wiring	29
IDENTIFICATION OF PARTS	9	<i>Connecting Fire Detectors</i>	29
The Status LEDs	9	<i>Connecting Call-points</i>	30
Description of Parts	14	<i>Connecting Gas Detectors</i>	30
Description of the Control keys	20	<i>Connecting Signalling Devices</i>	32
		<i>Connecting a Repeater</i>	32
		<i>Connecting Extinguishment Modules</i>	33
		Connecting a Dialler	34
		Connecting a Power Supply	34
		<i>Connecting the Mains Supply</i>	35
		<i>Thermal Probe</i>	35
		Maintenance	36
		Testing the Extinguishment Module	36

PROGRAMMING FROM A PC	37
Enrolling: Expander Modules	37
Enrolling: Extinguishment Modules	37
<i>Activation Mode</i>	38
<i>Times</i>	38
<i>Zones</i>	38
<i>Manual Extinguishment Input</i>	38
<i>Disable Extinguishment Input</i>	38
<i>Pressure Switch Input</i>	38
Enrolling: Power Supply Stations	38
Enrolling: Repeaters and LCD Modules	39
Zones	39
<i>Thresholds</i>	39
<i>Options</i>	40
<i>Times</i>	40
Outputs	40
<i>NAC1 Output</i>	40
<i>NAC2 Output</i>	41
<i>ALARM Output</i>	41
<i>OC Output Events</i>	41
<i>DL Output</i>	41
Panel Settings	42
<i>Day/Night</i>	42
<i>Reset</i>	42
<i>User Code</i>	42
<i>Alarm Verification Time</i>	42
<i>Extinguishment Termination Code</i>	42
<i>Night Mode Silence Time</i>	43
<i>Mains Failure Signalling Delay</i>	43
<i>Date/Time</i>	43
Downloading	43
<i>Restoring Factory Defaults</i>	44

PROGRAMMING FROM THE PANEL	45
Accessing the Programming session	45
Exiting the Programming Session	45
The “ZONES” Programming Phase	46
The “TIMES” Programming Phase	46
The “OUTPUTS” Programming Phase	47
The “PANEL” Programming Phase	47
<i>User Code (Key/LED 1)</i>	48
<i>Day Mode (Key/LED 2)</i>	48
<i>Night Mode (Key/LED 4)</i>	48
<i>Clock (Key/LED 5)</i>	48
<i>Date (Key/LED 7)</i>	48
<i>Mains Off Delay (Key/LED 8)</i>	48
The “VARIOUS” Programming Phase	48
<i>Stabilization Time (Key/LED 1)</i>	48
<i>Reset Time (Key/LED 2)</i>	48
<i>Non-Silenceable Outs (Key/LED 4)</i>	48
<i>Configuration 1 (Key/LED 5)</i>	49
<i>Configuration 2 (Key/LED 7)</i>	49
The “MODULES” Programming Phase	49
<i>Extinguish. time (Key/LED 1)</i>	49
<i>Pre-exting. time (Key/LED 2)</i>	49
<i>Man. Preest-Ex. T. (Key/LED 4)</i>	50
<i>Reset Inhibit T. (Key/LED 5)</i>	50
<i>Zones (Key/LED 7)</i>	50
LCD Module	50
<i>Programming Mode Address</i>	50
<i>Zones Descriptions</i>	50
<i>Strings Update</i>	50
<i>Date Format</i>	50

QUICK GUIDE	51
Technical features	51
Description of the terminals	51

The J424 and J408 Control panels

The reduced complexity **J424** and **J408** Fire Control panels are the fruit of attentive research and installer perception. The winning combination of expert workmanship, high quality materials and essential links among vital components provide maximum installation flexibility and performance.

The components of these Control panels operate as intended when the external ambient conditions comply with the requirements of EN60721-3-3:1995.

The **J424** and **J408** Control panels provides the following features: 8 Supervised/Bypassable input zones (the **J408-2** provides 2 and the **J408-4** provides 4); 2 Supervised/Silenceable/Bypassable fire outputs; 1 Silenceable fire output and 1 Silenceable/Bypassable fault alarm output.

The **J424** model has been especially designed for medium to large residential and commercial applications. It supports two 8 zone Expander Modules (providing a total of 24 zones); two Extinguishment Modules and an LCD Module and provides housing for two 12 V, 17 Ah batteries. This model is powered by a 2.5 A switching power supply.

The **J408** model has been especially designed for small residential and commercial applications. It is available with 2 (**TJ408-2**), 4 (**J408-4**) or 8 zones (**J408-8**). It supports 1 Extinguishment Module and provides housing for two 12 V, 7 Ah batteries. This model is powered by a 1.5 A switching power supply.

■ Accessory Items

J400-EXP8 Expander Module Kit. This kit comprises an 8 zone Expander Module and an Expander Control board. The Expander Module contains most of the electronic circuitry and electrical terminals whereas the Expander Control board provides the command keys and status LEDs of the Expander Module zones. The Expander Module and Expander Control board are intended for connection to the Main board of the Control panel. In the event of an alarm, the Expander Module will signal the status of its inputs to the Main board which will activate the fire warning and fire control devices and generate signalling on the Expander Control board. The **J424** accepts TWO **J400-EXP8** Expander Modules Kits.

J400-EXT Extinguishment Module

False activation of Fire Extinguishment systems may cause unnecessary inconvenience to end-users and serious damage to property. The **J400-EXT** Extinguishment Module aims at the reducing the false alarm rate by verifying alarm conditions before activating any Fire Extinguishment systems.

The **J408-8**, **J408-4** and **J408-2** Control panels support ONE Extinguishment Module Kit, whereas the **J424** Control panel supports TWO.

J400-LCD Display Module

This board has 6 scroll keys and a two-line backlit LCD (16 characters per line) which provides written information regarding the system status.

J400-REP Repeater panel

This Repeater panel is intended for connection (via 4 wires) to **J424** and **J408-8** Control panels. It provides all the visual and audible warnings generated by the Control panel and allows end-users to manage the system from a remote location (up to 1000 metres from the Control panel). The **J424** and **J408-8** Control panels support up to FOUR Repeater panels.

Software Management Software

This user-friendly software application (Windows) offers a quick and easy way to program the Control panel and provides event logger and print-out functions.

Description

■ Inputs

This Control panel has special inputs (detection zones) for fire detection devices, such as conventional fire detectors (i.e. devices which resemble the operating mode of open contacts during standby status and resistors during Alarm status) and similar devices, such as Callpoints and gas detectors.

The Control panel considers its inputs to be in standby status when they pull-down to 0 V with a 3900 ohm resistance. The inputs can detect and signal Automatic Alarms (generated by fire detectors), Manual Alarms (generated by Callpoints), shorted lines (generated by detector faults) and interrupted lines (generated by the removal of detectors from their bases).

 *EN 54-2 certification applies ONLY when no more than 30 devices are connected to each zone, and no more than 512 devices IN ALL are connected to the Control panel.*

■ Outputs

 This Control panel accepts devices that operate within SELV limits ONLY.

This section describes how the Control panel outputs operate.

Supervised outputs The Control panel will be able to detect and signal short-circuits and power supply interruptions on this type of output.

Bypassable outputs The user will be able to disable (by means of the respective key) this type of output.

Silenceable outputs The user will be able to stop (via the **Silence** key) this type of output
The outputs can be silenced for an indefinite period (during Day Mode) or, for the programmed Silence Time (during Night Mode).

This Control panel provides the following alarm outputs:

- two Supervised/Silenceable/Bypassable outputs (**NAC1** and **NAC2** terminals) with positive polarity (27.6 V) during alarm status;
- one Silenceable/*NON-Supervised/NON-Bypassable* Volt-free changeover contact (**ALARM** terminals) for devices which cannot be connected directly to **NAC1** or **NAC2**;
- one Supervised/Bypassable/*NON-Silenceable* output (**DL** terminal), intended for use with telephone devices that pull-down to 0 V (negative) in the event of an alarm;
- one Silenceable/*NON-Supervised/NON-Bypassable* output for each input zone (terminals **R1**, **R2**, ..., **R8**) that will pull-down to 0 V (negative) when the respective zone generates an alarm. These outputs allow selective action, as they activate only the devices connected to the zone concerned.

 The **NAC1**, **NAC2** and **DL** outputs comply with EN54-2.

This Control panel also provides:

- one Silenceable/*NON-Supervised/NON-Bypassable* Volt-free changeover contact (**TROUBLE** terminals) that will activate in the event of trouble;
- one *NON-Supervised/NON-Bypassable/NON-Silenceable* open-collector output (**OC** terminal) that will pull-down to 0 V (negative) when the associated event occurs (Alarm, Pre-alarm, Fault, Reset, Bypass, Test or Double knock);
- one *NON-Supervised/NON-Bypassable/NON-Silenceable* changeover contact (**PL** terminal) that will pull-down to 0 V (negative) in the event of power failure to the Control panel.

■ Operating features

Pre-alarm If a zone generates an alarm during Day Mode (**Night Mode** LED OFF), the Control panel will start the **Pre-alarm Time**. This status will be signalled by:

- a **slow intermittent** beep;
- blinking on the LED of the **Zone Alarm** that generated the Alarm;
- glowing on the **Pre-al.** LED;
- activation of the **NAC1** and **NAC2** outputs — in accordance with programming;
- Negative pull-down to 0 V on the **R** terminal of the zone that generated the Alarm, that is, if the **Pre-alarm on R output** option is enabled;
- Negative pull-down to 0 V on **OC** terminal, that is, if it is programmed to signal **Pre-alarm**.

 This Control panel will generate an Instant Alarm if alarm conditions are detected during **Night Mode** (**Night Mode** LED glowing) or, if an alarm is triggered from a Callpoint connected to a zone enabled for **Call point Priority** (i.e. the **Call point Priority** option ENABLED).

During Pre-alarm status, **all persons** on the premises (**Access Level 1** — refer to “Access to signalling and commands”) will be able to:

- activate an Evacuation Alarm by pressing and holding the **Ack./Evac.** key for **AT LEAST 5 seconds**.

During Pre-alarm status, **Key** and **PIN Code users** (**Access Level 2** — refer to “Access to signalling and commands”) will be able to:

- add the **Investigation Time** to the **Pre-Alarm Time** by pressing (for **LESS THAN 5 seconds**) the **Ack./Evac.** key;
- activate an Evacuation Alarm by pressing and holding the **Ack./Evac.** key for **AT LEAST 5 seconds**;
- stop the Silenceable outputs and interrupt the Pre-alarm Time by pressing the **Silence** key.

During **Silence** status (**Silence** LED glowing), it is possible to use the **Silence** key to release the **Silenceable** outputs and restart **Pre-alarm Time** or, use the **Reset** key to restore standby status.

 If the Control panel is operating in **Night Mode** (**Night Mode** LED glowing), the Control panel will exit **Silence** status automatically when the programmed **Night mode Silence time** expires.

Alarm The Control panel will generate an alarm when the **Pre-Alarm Time** expires. Alarm status will be signalled by:

- a **fast intermittent** beep;
- glowing on the LED of the **Zone Alarm** that generated the Alarm;
- glowing on the **Alarm** LED;
- activation of the **NAC1** and **NAC2** outputs — in accordance with programming;
- Negative pull-down to 0 V on the **R** terminal of the zone that generated the Alarm;

- Negative pull-down to 0 V on the **OC** terminal, that is, if it is programmed to signal **Alarm** status.

☞ *The Control panel will activate the DL output when the programmed **Alarm Signalling delay** expires.*

During Alarm status, **Key** and **PIN Code users (Access Level 2)** — refer to “Access to signalling and commands”) will be able to:

- stop the Silenceable outputs by pressing the **Silence** key.

During **Silence** status (**Silence** LED glowing), it is possible to use the **Silence** key to release the **Silenceable** outputs, and the **Reset** key to restore standby status.

☞ *If the Control panel is in Night Mode (**Night Mode** LED glowing), the Control panel will exit **Silence** status when the programmed **Night mode Silence time** expires.*

Trouble This Control panel can detect and signal the following Trouble:

- Input zone shorted or open;
- Supervised zone shorted or open;
- Control panel blocked;
- Output 24V or 24R shorted;
- Low battery, battery trouble or disconnected battery;
- Ground fault;
- Communication trouble with peripherals;
- Mains failure.

Fault conditions will be signalled by:

- a **slow intermittent** beep (at 1 second intervals);
- glowing on the **Fault** LED;
- fast blinking on the LED of the “component” concerned (the **Logic Unit** LED will glow to signal “Control panel blocked”);
- activation of the **Fault** output (**TROUBLE** terminals);
- Negative pull-down to 0 V on **OC** terminal, that is, if it is programmed to signal **Fault**.

The **Fault** output (**TROUBLE** terminals) and **OC** outputs (if duly programmed by your Installer) will restore to standby automatically when fault conditions clear.

Under certain circumstances, fault conditions may clear spontaneously, if this occurs, the event will be stored in the memory until the Control panel Resets.

Stored Fault events will be signalled by:

- slow blinking on the LEDs of the “component” concerned.

Silence This Control panel provides a **Silence** key which can be used to restore the Silenceable outputs to standby status:

- R1, R2, ..., R8
- NAC1 and NAC2
- ALARM
- TROUBLE

Silence status will be signalled by:

- an audible signal (lasting 1 second) followed by a long pause (lasting 5 seconds);
- glowing on the **Silence** LED.

Silence status will be held until the **Silence** key is pressed again or, if the Control panel is operating in **Night Mode**, until the programmed **Night mode Silence time** expires, or until a new Alarm or Trouble condition is detected.

☞ *ONLY **Key** and **PIN Code Users** (Access Level 2) can **SILENCE** the Silenceable outputs.*

Disable This Control panel provides keys which can be used to disable the bypassable inputs and outputs:

- **Z1, Z2, ... Z24** can be used to bypass (exclude) their respective zones;
- **Disab./Fault NAC** can be used to bypass outputs **NAC1** and **NAC2**;
- **Disab./Fault Telecom** can be used to bypass the **DL** output.

DISABLED zones cannot generate alarms or warnings of any kind, and DISABLED outputs cannot be activated.

Disabled status will be signalled by:

- glowing on the **Disab.** LED;
- glowing on the LED of the respective zone or output (see LEDs: **Disabled/Fault/Test**, **Disab./Fault NAC** and **Disab./Fault Telecom**).

☞ *ONLY **Key** and **PIN Code Users** (Access Level 2) can **DISABLE** zones and/or outputs.*

Reset Resetting the Control panel will restore the outputs to standby status, delete the memory, and interrupt the power supply to terminals Z1, Z2, ..., Z8 and 24R for the programmed Reset Time.

☞ *ONLY **Key** and **PIN Code Users** (Access Level 2) can **Reset** the system. Fire alarms must be **Silenced** (via the **Silence** key) before **Reset**. Fault conditions can be **Reset** directly (via the **Reset** key).*

■ Interface

Visual Signalling The system status will be signalled on the Control panel LEDs as follows:

GREEN indicates normal operating conditions;
AMBER indicates specific operating modes (for example Day or Night mode), and/or Fault conditions;
RED indicates Alarm conditions.

Memory The Control panel will signal Alarm/Fault events until the system Resets, even if the event clears in the meantime.

Stored events will be signalled by:

- slow blinking on the LED concerned.

Display The **J424** Control panel can house the **J400-LCD** Module. This module provides written information regarding the system status, and the cause of faults on inputs and outputs (short-circuit, interruption etc.).

Audible Signalling The Buzzer will signal the Control panel status as follows:

Status	Sound	Pause	Description
Pre-alarm	0.5 s	0.5 s	Intermittent beep
Alarm	0.2 s	0.2 s	Fast Intermittent beep
Fault	1 s	1 s	Slow Intermittent beep
Silence	1 s	5 s	Long beep/Long pause
Reset	0.5 s	0.1 s	Short beep/Short pause
Test	1 s	3 s	Long beep/Long pause

Test This key will allow ALL users to test the Control panel Buzzer and LEDs (Access level 1), and **Key** and **PIN Code Users** to test the zones (Access level 2).

To test a zone: press the respective Zone key (**Z1**, **Z2**, ..., **Z24**) and the **Test** key simultaneously.

■ Extinguishment Module

This section describes how the **J400-EXT** Extinguishment Module operates.

Activation Mode The Fire Extinguishment systems may be activated by alarm conditions on ONE of the programmed zones (**OR Mode**), at least TWO of the programmed zones (**At least two Mode**), or ALL of the programmed zones (**ALL Mode**).

Pre-Extinguishment If the programmed 'Activation Mode' conditions occur, the Extinguishment Module will start the Pre-Extinguishment phase (indicated by glowing on the **Pre Ext.** LED and by activation of the Module **PR** outputs) but will not activate the respective Fire Extinguishment systems immediately, thus allowing users to verify the Alarm.

 *The Pre-Extinguishment and Extinguishment conditions are ignored in the event of a fault in the PR Output and/or the IE Output.*

Extinguishment If the 'Activation Mode' conditions are still present when the programmed Pre-Extinguishment time expires, the Extinguishment Module will activate the Extinguishment phase (indicated by glowing on the **Electrovalve** LED and by the activation of the Module's **AE** output). The Fire Extinguishment systems, (connected to the Module's **EV** output) will stay On until the alarm conditions cease, or until the programmed Extinguishment Time expires (i.e. if the **Bistable** option is disabled), or until the **Disable Extinguish** key is pressed. The Extinguishment status ceases when the Control panel is reset or after the programmed Extinguishment Time (if the **Bistable** option is disabled).

 *The Pre-Extinguishment and Extinguishment conditions are ignored in the event of a fault in the PR Output and/or the IE Output.*

Auxiliary Supervision Inputs The Extinguishment Module provides supplementary supervision inputs for Extinguishment Inhibition, Manual Extinguishment and Pressure Switch control. These **Supervised** inputs must pull down to 0 V (negative) with a 3.900 ohm resistance during standby status. In the event of interruption or short-circuit, these inputs will generate a warnings on the LED concerned.

■ Access to Signalling and Commands

There are 4 access levels, in compliance with the Fire Safety Regulations in force.

Access Level 1 Viewing: **ALL** persons can view the Control panel status.

Access Level 2 Operating the system (PIN Code entered or Key turned in the Keyswitch): **ONLY Key** and **PIN Code Users** can operate the system.

Access Level 3 Opening the Control panel: **ONLY Qualified persons with authorization** are allowed to open the Control panel door (requires removal of the screws) for maintenance purposes.

Access Level 4 Repairing or replacing the PCB: **ONLY the Manufacturer** should be allowed to repair or replace the PCB.

■ Power Supply

The power supply system of the **J424** and **J408** Control panels complies with EN54-4.

Both models are powered by the Mains (230 V, 50 Hz):

- the **J408** model has Switching Power Supply which supplies up to 1.5 A at 27.6 V;
- the **J424** model has Switching Power Supply which supplies up to 2.5 A at 27.6 V;

Both models can house two 12 V batteries which, when connected in series, will supply 24 V to the Control panel and peripherals in the event of black-out, and will also provide any pickup currents which exceed the maximum current supplied by the Switching Power Supply. Power Supply:

- the **J408** model can house two 7 Ah batteries (YUASA NP 7-12 FR model or similar — flame class UL94-V2 or higher);
- the **J424** model can house two 17 Ah batteries (YUASA NP 17-12 FR model or similar — flame class UL94-V2 or higher).

This Control panel can detect, signal and store in memory the following power faults: shorted 24V or 24R outputs (**24V/24R** LED); Low battery, Battery fault or Battery disconnected (**Battery** LED), Ground fault (**Ground** LED) and Mains failure (**Mains** LED).

 *The "Battery Disconnected" fault may be signalled with a delay of up to 1 minute. The "Mains" fault will be signalled when the programmed delay expires.*

IDENTIFICATION OF PARTS

The Status LEDs

The following section describes how the Control panel LEDs operate, and the actions that can be taken during the various phases signalled on the LEDs. During standby status ONLY the GREEN Mains LED should be On (glowing).

 Some LEDs indicate more than one status, however, in most cases the LEDs signal as follows:
ON (glowing) indicates DISABLED status;
Fast blinking indicates a FAULT condition;
Slow blinking indicates an ALARM/FAULT event in memory.

LED	DESCRIPTION
Alarm	Glowing indicates Alarm status. In the event of an Alarm, the Control panel will activate the unbypassed alarm outputs.
Pre-alarm	Glowing indicates Pre-alarm status.
Test	Glowing indicates Test conditions on at least one zone.
Disab.	Glowing indicates the Disabled status of the NAC, Telecom, Zone and Extinguishment outputs, or inhibition of Manual or Automatic Extinguishment.
Telecom	Glowing indicates that the Telephone device output is active (negative pull-down to 0 V on terminal [DL]).
Green Mains	OFF indicates Mains failure (230 V). IMPORTANT: Power must be restored before the batteries empty.
Fault	Glowing indicates one of the following Faults: Blocked Control panel; Shorted 24V or 24R output; Empty Batteries; Disconnected Battery; Ground Fault; Mains Failure; Zone Trouble; Shorted or Open NAC or DL output; Extinguishment Module Trouble; Peripheral Trouble.
Logic Unit	Glowing indicates Blocked Control panel. IMPORTANT: Maintenance required. NOTE – When the Control panel is switched on for the first time, this LED will flash until a Reset has been performed.
24V/24R	Fast blinking indicates Shorted 24V or 24R output.
Battery	Fast blinking indicates Batteries empty, disconnected or faulty. If this condition persists, the batteries will be unable to function as intended in the event of blackout, IMPORTANT: New batteries required.
Ground	Fast blinking indicates a Voltage leakage to Earth. IMPORTANT: Check wiring insulation.
Periph	Fast blinking indicates communication trouble with peripherals.
Amber Mains	Fast blinking indicates Mains failure (230 V) or Switching Power supply fault. During this condition, the Control panel will be powered by the batteries. Mains failure is also signalled on the Green Mains LED (OFF), however, this LED also signals Mains Failure in Memory (Slow blinking).
Silence	Glowing indicates that Silenceable outputs (terminals [NAC1], [NAC2], [DL], [TROUBLE], [ALARM] (if programmed) and [Rn] (if programmed) have been manually forced to standby by means of the respective key.
Ack./Evac.	Glowing indicates that the programmed Investigation time is running.
Reset	Glowing indicates that Reset operations cannot be carried out.
Night Mode	Glowing indicates that the Control panel is operating in Night Mode.
Disab./Fault NAC	Glowing indicates that the Supervised, Silenceable Fire Alarm outputs (terminals [NAC1] and [NAC2]) have been disabled by means of the respective key, therefore, in the event of alarm will not be activated. Fast blinking indicates that at least one of the Supervised, Silenceable Fire Alarm outputs (terminals [NAC1] and [NAC2]) is shorted or open.
Disab./Fault Telecom	Glowing indicates that the telephone device output (terminal [DL]) has been disabled by means of the respective key, therefore, in the event of an alarm will not be activated. Fast blinking indicates that the telephone device output (terminal [DL]) is shorted or open.
Disabled/Fault/Test	Glowing indicates that the respective zone has been disabled by means of the respective key, therefore, will be unable trigger alarms. Fast blinking indicates that the respective zone is shorted or open, therefore, unable to detect alarm conditions.
Zone Alarm	Glowing indicates that the respective zone has detected alarm conditions.

Table 1 Description of the status LEDs ... (continued on page 20)

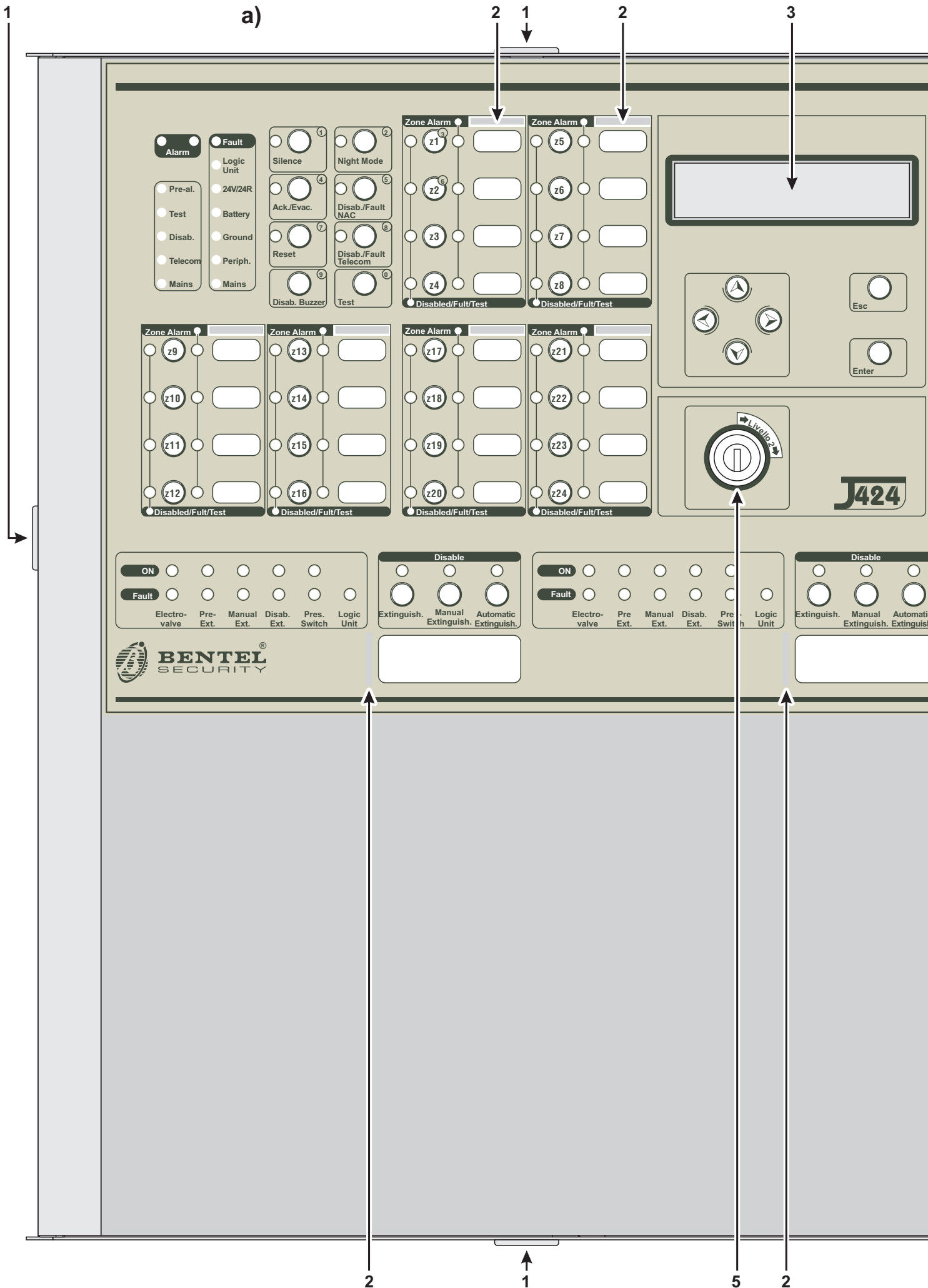
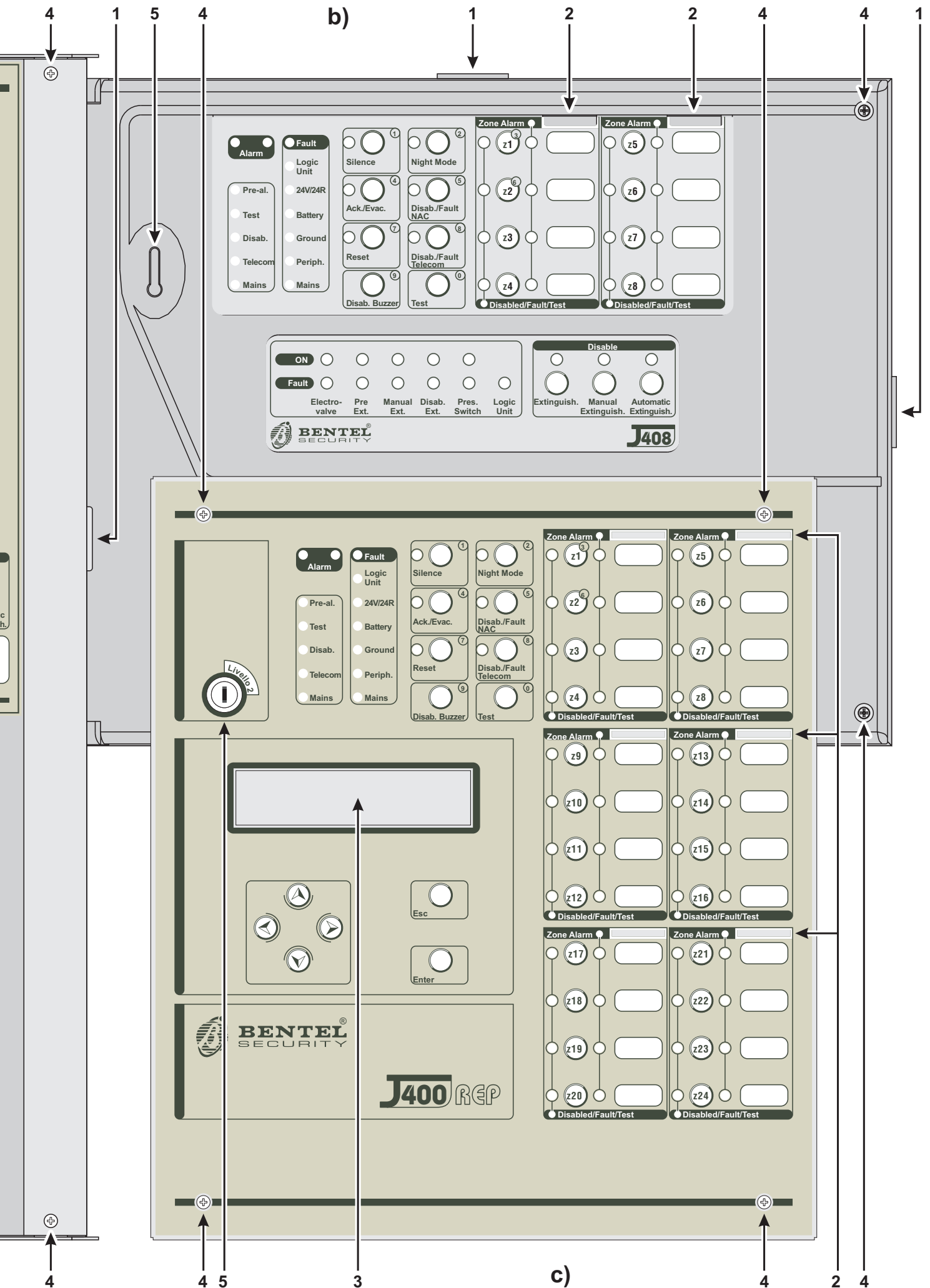

Figure 1 Front view of the J424 Control panel J424 (a), J408 Control panel (b) and J400-REP Repeater (c)



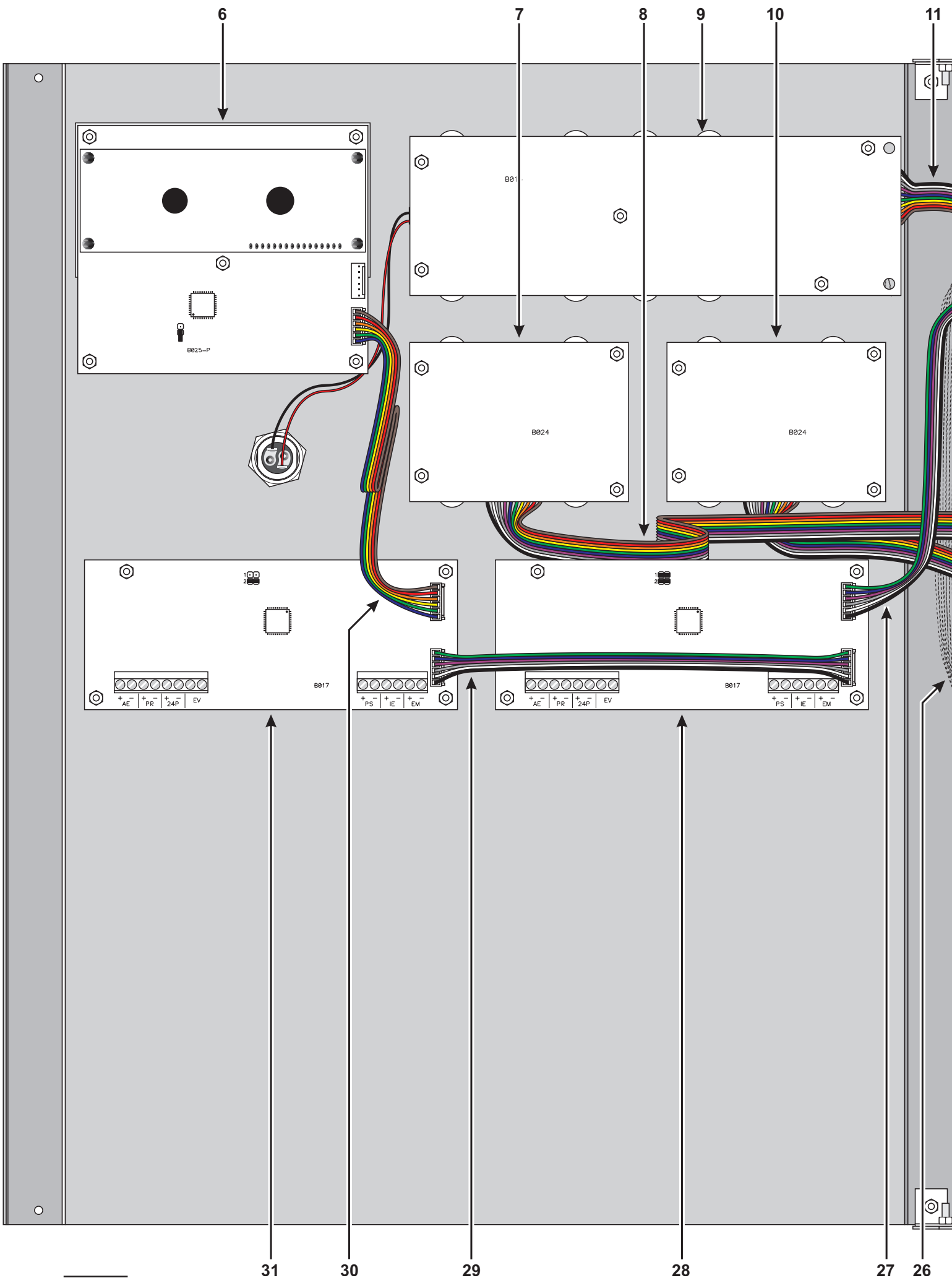
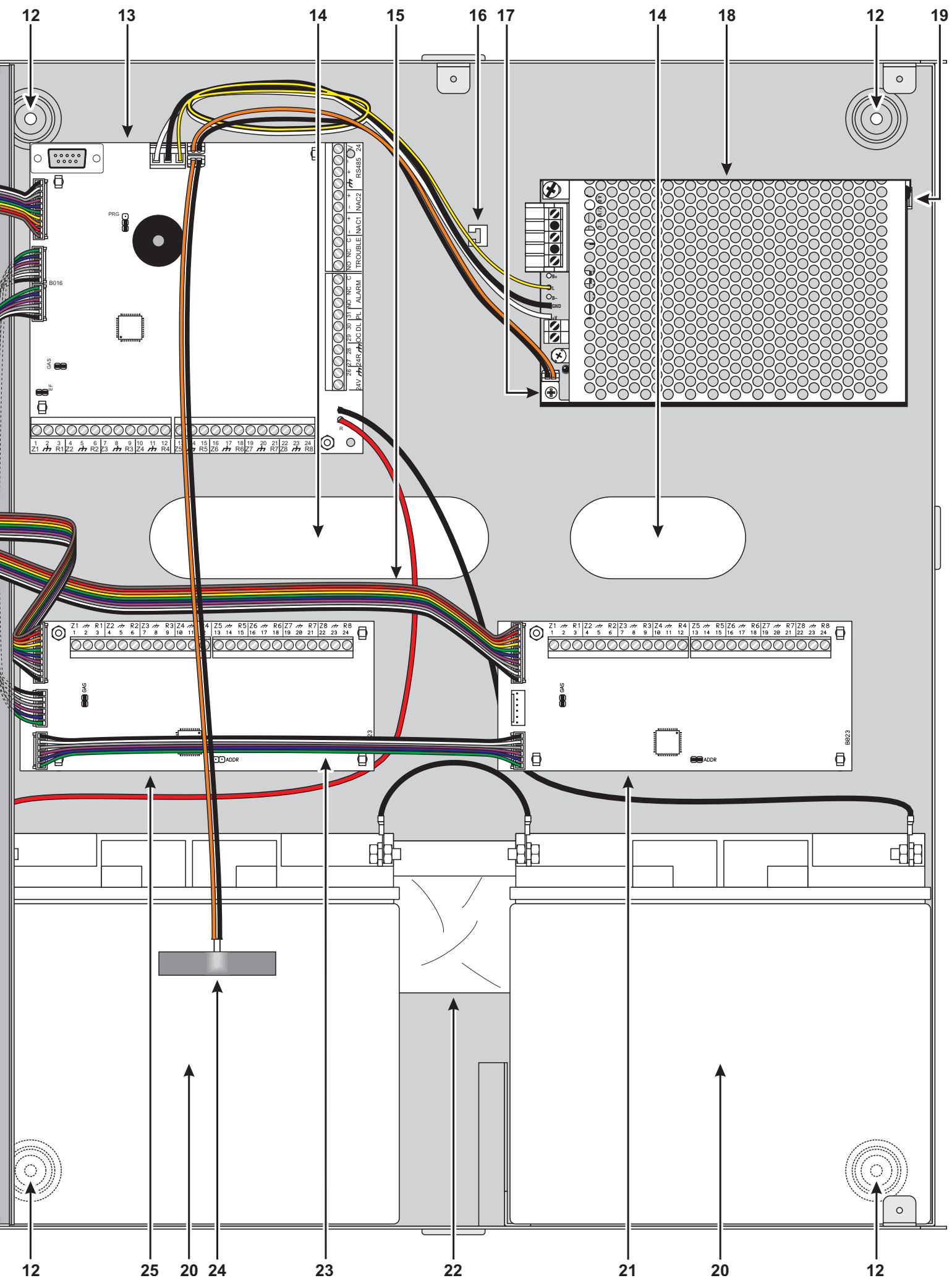

Figure 2 Maximum configuration of the J424 Control panel



IDENTIFICATION OF PARTS

Description of Parts

This section describes the components of the J424 and J408 Control panels, and J400-REP Repeater.

Unless otherwise stated, the numbers in boldface in this Manual refer to the Tables and Diagrams in this section.

The parts identification numbers in the diagrams go clockwise. The white numbers refer to parts which are common to several of the system devices, therefore, are described the first time they are encountered only.

P.	Description
1	Surface Cable conduit entry
2	Zone label slots
3	Display
4	Door screws
5	Keyswitch (Access Level 2)
6	Display module (accessory item)
7	Expander Control board (LEDs and keys) of Expander no. 2 (accessory item for J424)
8	Flat cable (accessory item for J424): for the Expander Control board connection
9	Main Control board (LEDs and keys) of zones 1 through 8
10	Expander Control board (LEDs and keys) of zones 9 through 16 (accessory item for J424)
11	Flat cable: for the Main Control Board connection (zones 1 through 8)
12	Anchor screw locations
13	Main board (2, 4 or 8 zones)
14	Chased cable conduit entry
15	Flat cable (accessory item for J424): for the Expander Control board connection

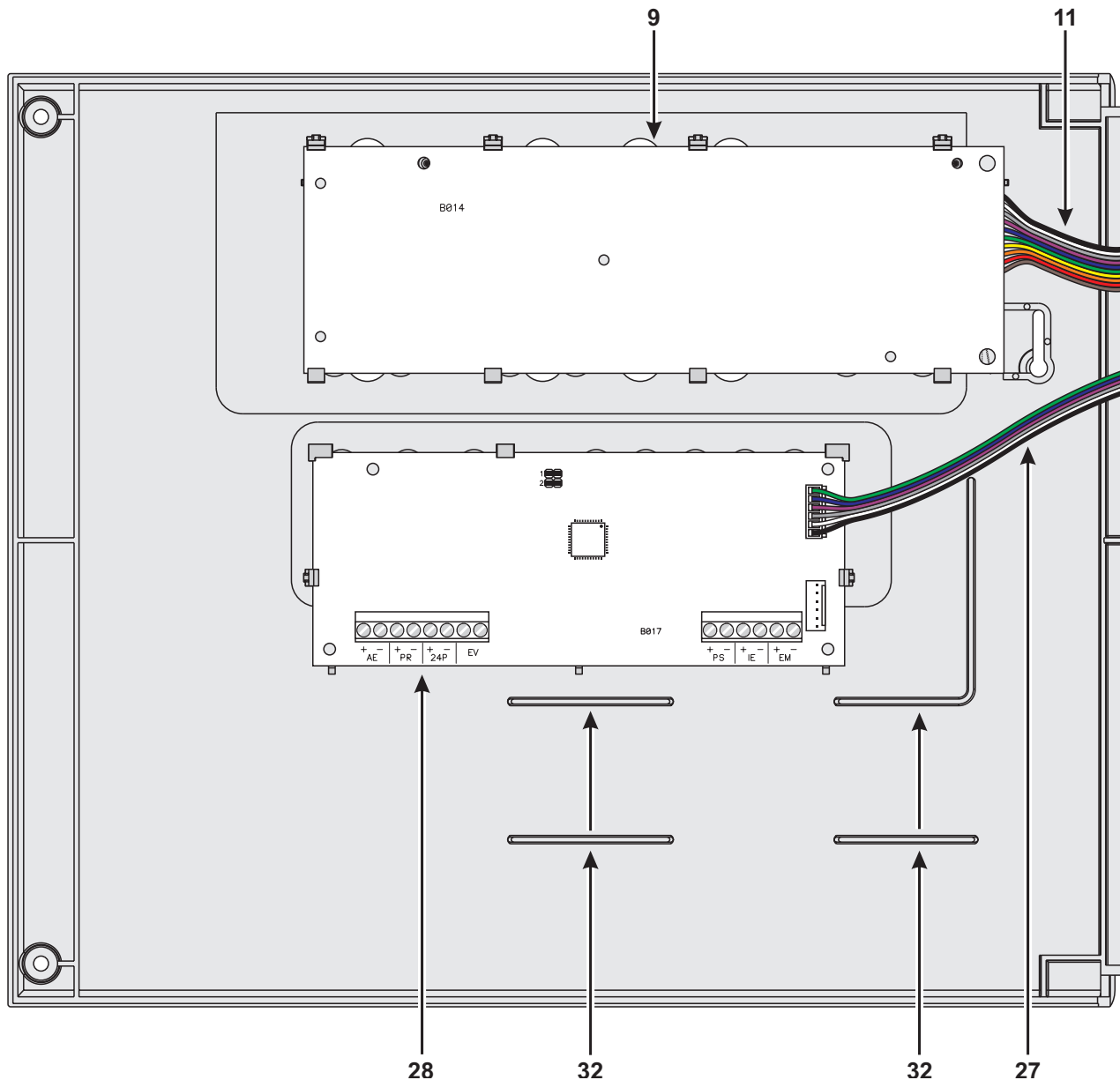
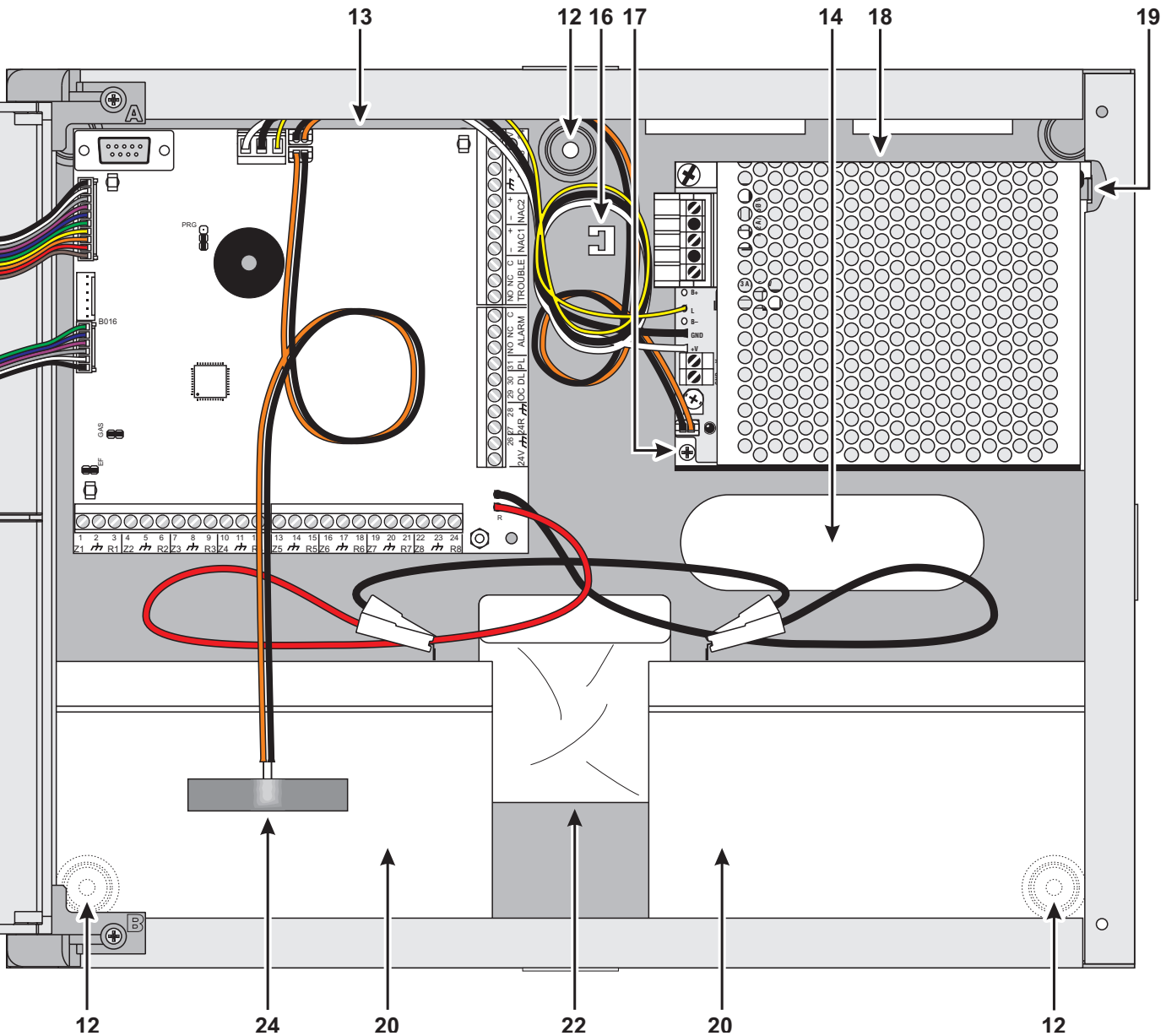

Figure 3 Maximum configuration of the **J408** Control panel

P.	Description
16	Anchor for 230 V power supply wires
17	Switching power supply screws
18	Switching power supply/Battery charger
19	Switching power supply support
20	Batteries (NOT supplied!): J408 = two 7 Ah @ 12 V J424 = two 17 Ah @ 12 V
21	Expander no. 1 (accessory item)
22	Bag containing keys, resistors and diodes
23	Flat cable (accessory item): for the Expander Module no. 1 to Expander Module no. 2 connection
24	Thermal probe
25	Expander Module no. 2 (accessory item)
26	Flat cable (accessory item): for the Expander Module no. 1 to Main board connection
27	Flat cable (accessory item): for the Extinguishment Module to Main board connection
28	Extinguishment Module no.1 (accessory item)

P.	Description
29	Flat cable (accessory item): for the Extinguishment Module no. 1 to Extinguishment Module no. 2 connection
30	Flat cable (accessory item): for the Display Module connection
31	Extinguishment Module no.2 (accessory item)
32	Wire run



P.	Description
33	Anchor screw location holes
34	Chased cable conduit entry
35	RS485 Interface
36	Soldered Earthing screw

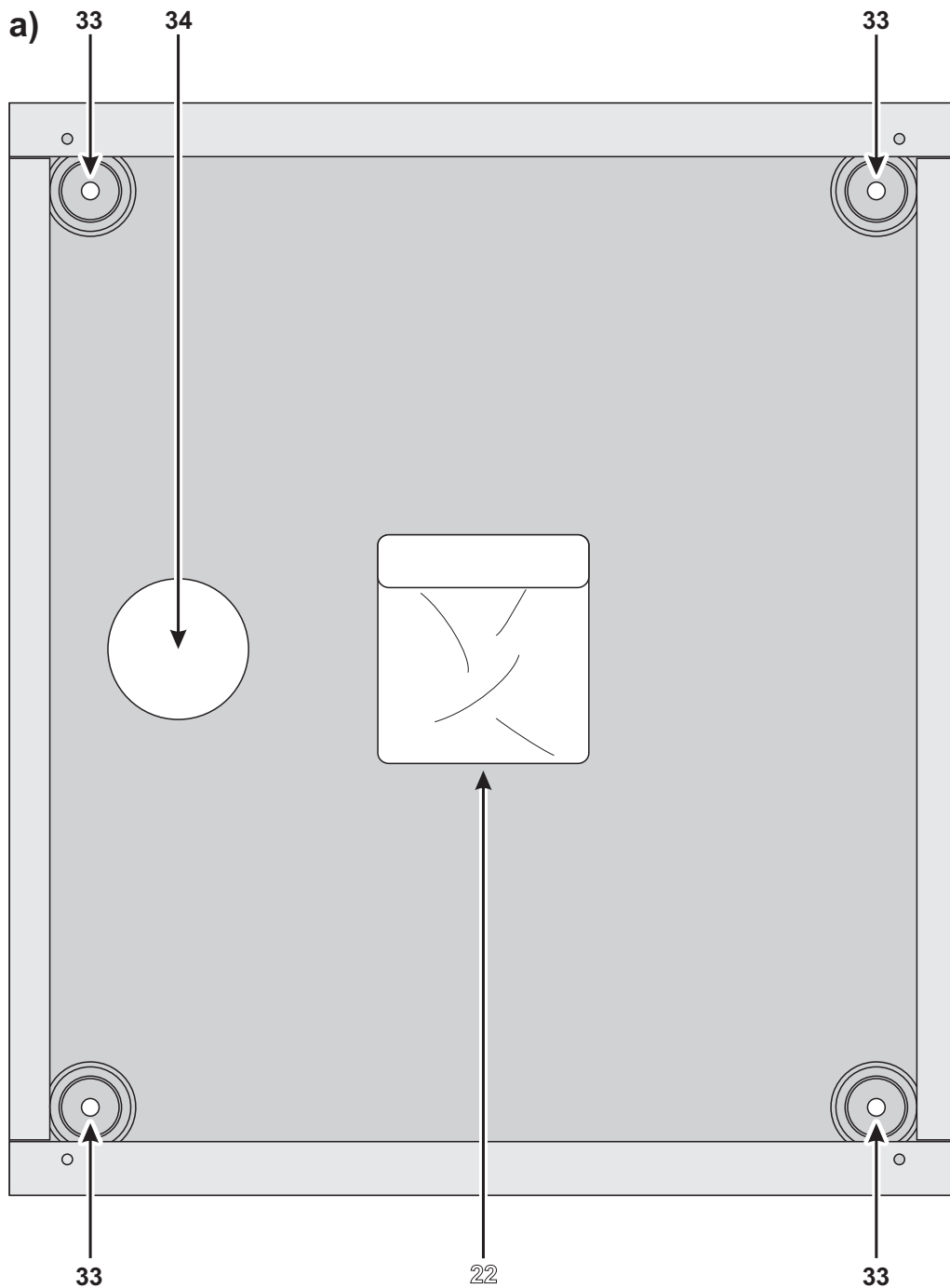
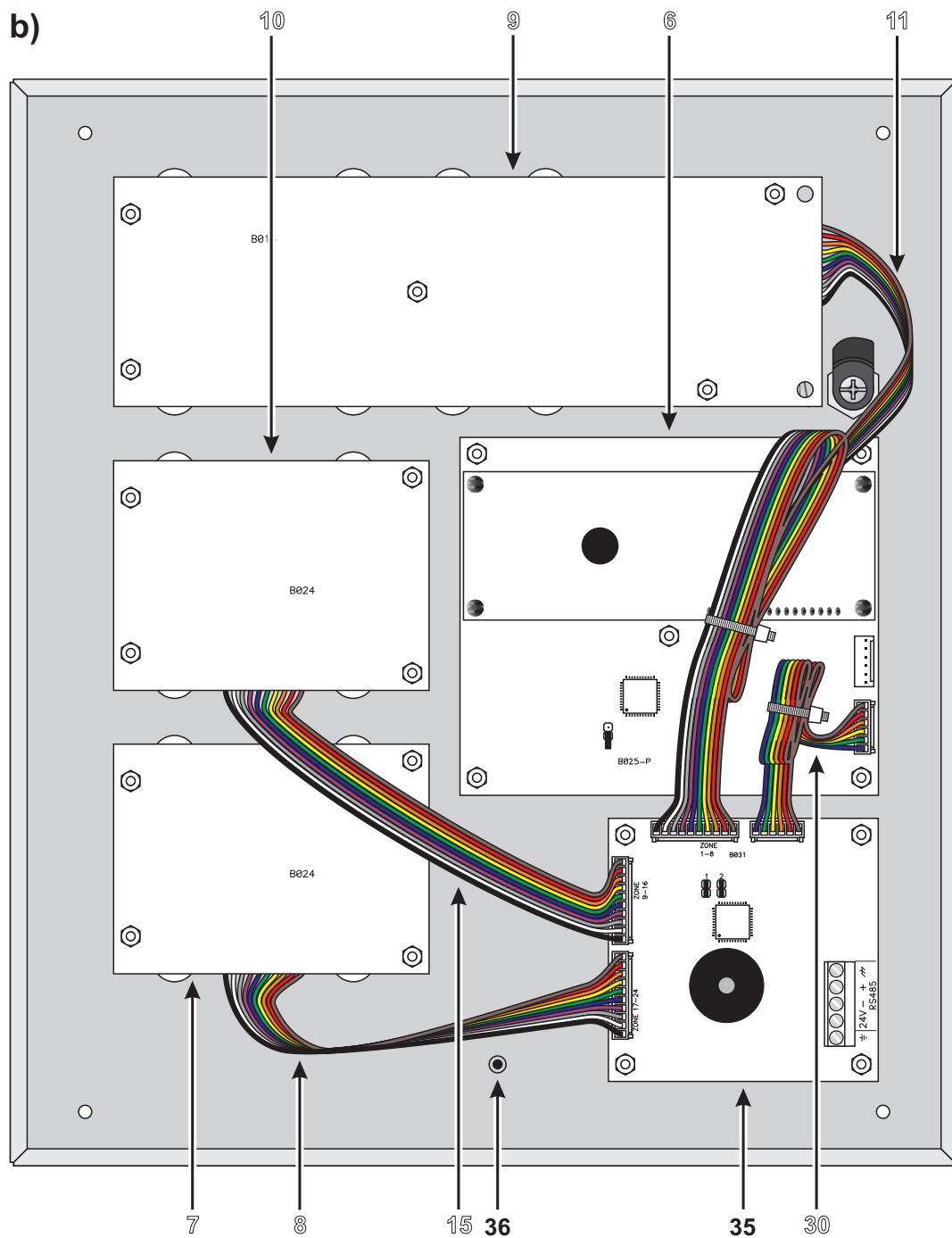









Figure 4 Maximum configuration of the **J400-REP** Repeater: **a)** backplate; **b)** frontplate (inside view)



P.	Description
37	Battery output voltage control output (connected at factory)
38	Thermal probe jack
39	Switching-power-supply jack (connected at factory)
40	Buzzer
41	Terminal board
42	Extinguishment Module anchor holes
43	Address Jumper:  = Extinguishment Module no. 1  = Extinguishment Module no. 2
44	Terminal board
45	Cable: connects the Switching power supply to the Main board (connected at factory)
46	Switching-power-supply anchor
47	Switching-power-supply closure rivet
48	Mains indicator LED
49	Switching-power-supply anchor hole
50	Switching-power-supply output voltage control input (connected at factory)
51	Fine trimmer for the Switching-power-supply output Voltage
52	Auxiliary power-supply terminals (27.6 V)
53	Mains power terminals (230 V / 50 Hz)
54	Switching-power-supply screws
55	Switching-power-supply fuse — protects against overload: J408 = F 2A 250V J424 = F 3.15A 250V
56	Jack for Extinguishment Module nr. 2 or the Display Module
57	Microprocessor
58	Jack for the Main board or Display Module
59	Reserved Jumper — DO NOT REMOVE
60	Battery jacks
61	Jumper for Ground (Earth) fault detection:  = Ground (Earth) fault monitored  = Ground (Earth) fault NOT monitored
62	Jumper — to be REMOVED when connecting a 4-20 mA gas detector to terminal Z1
63	Jack for Extinguishment Module nr. 1 or the Display Module
64	Expander Module jack
65	Programming Jumper: PRG  Programming  Disabled PRG  Programming  Enabled
66	Expander Control board jack (connected at factory)
67	RS232 Serial Port

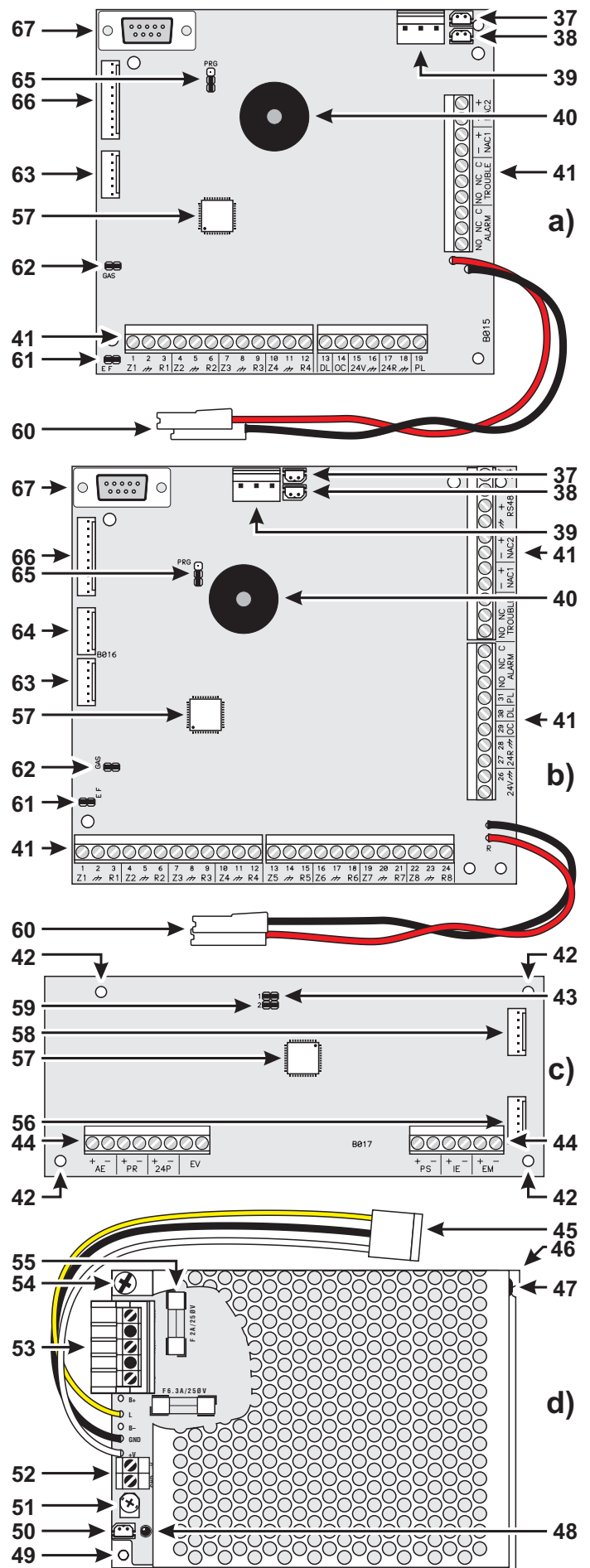





Figure 5 Identification of Parts: **a)** Main Board (2 or 4 zones); **b)** 8-zone Main Board; **c)** Extinguishment Module; **d)** J408 Control panel Switching-power-supply

P.	Description
68	Expander Module anchor holes (4)
69	Terminal strip
70	Address Jumper:  = Expander Module no. 1  = Expander Module no. 2
71	Expander Control Board anchor holes (4)
72	Jack for the Expander Control Board to Expander Module connection
73	Display Module anchor holes (5)
74	Jack for the connection between the Display Module and the consecutive peripheral device
75	Jack for the connection between the Display Module and the preceding peripheral device
76	Address Jumpers
77	Terminal strip
78	Buzzer
79	Jack for the Expander Control board (zones 17 to 24)
80	Jack for the Expander Control board of zones 9 to 16
81	Jack for the Expander Control board of zones 1 to 8
82	Display module Programming Jumper:  = Programming Enabled  = Programming Disabled
83	Jack for the connection between the Expander Module and the consecutive peripheral device
84	Jack for the connection between the Expander Module and the preceding peripheral device or Main Board
85	Expander Control Board jack

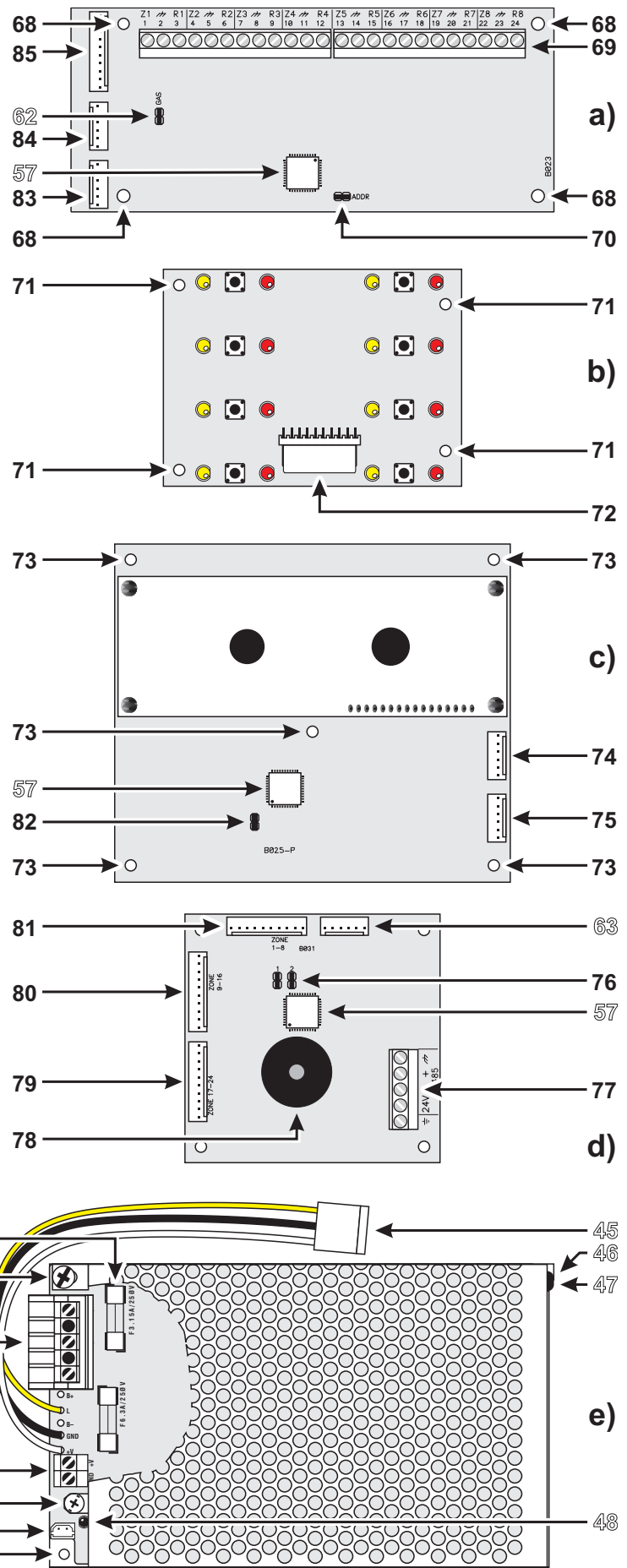

Figure 6 Identification of Parts: **a)** Expander Module; **b)** Expander Control Board; **c)** Display Module; **d)** RS485 Repeater Interface; **e)** J424 Control panel Switching-power-supply

LED	ON	Fault
Electro-valve	Glowing indicates “Extinguishment” in course	Fast blinking indicates power supply failure to the electrovalve connected to output EV , or that the latter is either open or shorted
Pre Ext.	Glowing indicates “Pre-Extinguishment” in course. Fast blinking indicates that alarms have been generated in some of the zones programmed for activation of the Extinguishment Module.	Fast blinking indicates that terminals [+] and [–] of output PR are either disconnected or shorted
Manual Ext.	Glowing indicates that input EM has been activated	Fast blinking indicates that terminals [+] and [–] of input EM are either disconnected or shorted
Disab. Ext.	Glowing indicates that input IE has been activated	Fast blinking indicates that terminals [+] and [–] of input IE are either disconnected or shorted
Pres. Switch	Glowing indicates that the input PS has been activated, due to low extinguishant gas pressure	Fast blinking indicates that terminals [+] and [–] of input PS are either disconnected or shorted
Logic Unit	—	Fast blinking indicates “blocked” Extinguishment Board
Disable Extinguish.	Glowing indicates “Extinguishment” is inhibited	
Disable Manual Extinguish.	Glowing indicates “Manual Extinguishment” is inhibited	
Disable Automatic Extinguish.	Glowing indicates that “Automatic Extinguishment” is inhibited	

Table 1 (continued from page 9) ... Description of the LEDs

Description of the Control keys

The Control panel keys can be activated by Keyswitch and PIN Code Users ONLY (Access level 2 — Key tur-

ned in keyswitch or PIN Code entered — refer to “Access to Signalling and Commands”), unless otherwise stated.

Key	DESCRIPTION
Silence	This key can be used to restore the Silenceable outputs to standby status (terminals [NAC1], [NAC2], [DL], [TROUBLE], [ALARM — if programmed] and [Rn — if programmed]). Silence status will be held until the Silence key is pressed again or, if the Control panel is operating in Night Mode , until the Night mode Silence time expires or until a new Alarm/Trouble condition is detected
Ack./ Evac.	This key can be used to refresh the “Pre-Alarm Time” or trigger an Alarm: For all persons on the premises: If this key is pressed for over 5 seconds during “Pre-Alarm Time”, the system will generate an alarm. For Key and PIN Code Users ONLY (Access level 2): If this key is pressed during “Pre-Alarm Time”, the remaining Pre-Alarm Time will be refresh with the programmed Investigation Time . If it is pressed for over 5 seconds during “Pre-Alarm Time”, the system will generate an alarm
Reset	This key can be used to reset the Fire detectors and restore all outputs to standby status (Supervised/Silenceable outputs, NON-Supervised/Non-Silenceable outputs and Alarm zone outputs)
Disab. Buzzer	This key can be used to disable the buzzer. The buzzer will be re-enable if any kind of event occurs.
Night Mode	This key can be used to switch from Day to Night Mode
Disab./Fault NAC	This key can be used to disable the Bypassable Fire alarm outputs (terminals [NAC1] and [NAC2]).
Disab./Fault Telecom	This key can be used to disable the Telephone device output (terminal [DL])
Test	This key can be used to test the zones, buzzer and LEDs . If this key is pressed (when the Control panel is functioning as intended), all the LEDs will Glow and the buzzer will emit a continuous beep. For Access level 2 Users ONLY: If this key is pressed with the Disable key of a zone (z1 , z2 , ..., z24) it will activate the respective zone test phase
z1 ... z24	These keys can be used to disable their respective zones. Disabled zones will provide visual signalling of fire and fault conditions but will not activate any outputs or store events in Memory
Disable Extinguish	This key can be used to disable the “Extinguishment” function.
Disable Manual Extinguish	This key can be used to disable the “Manual Extinguishment” function. If this function is disabled, it will not be possible to activate Extinguishment function via the EM input.
Disable Automatic Extinguish	This button can be used to disable the “Automatic Extinguishment” function. If this function is disabled, the zones will not be able to activate Extinguishment”.

Table 2 Description of keys

INSTALLING THE CONTROL PANEL

! Installation of this system must be carried out strictly in accordance with the instructions in this section, and in compliance with the local safety regulations in force.

- Choose suitable mounting locations for the Control panel, detectors, fire warning and fire control devices.
- Lay the cables between the Control panel and the system peripherals.
- If necessary, install any accessory modules (Expanders, etc.).
- Mount the Control panel to the wall.
- Carry out the necessary connections, leaving the power-supply connection until last.
- Program the Control panel in accordance with the instructions in the "PROGRAMMING" section.
- Test the entire system (Control panel, detectors, fire warning and fire control devices).

! Accessory Modules (Expanders Modules, Extinguishment Modules, etc.) should be installed before mounting the Control panel to the wall.

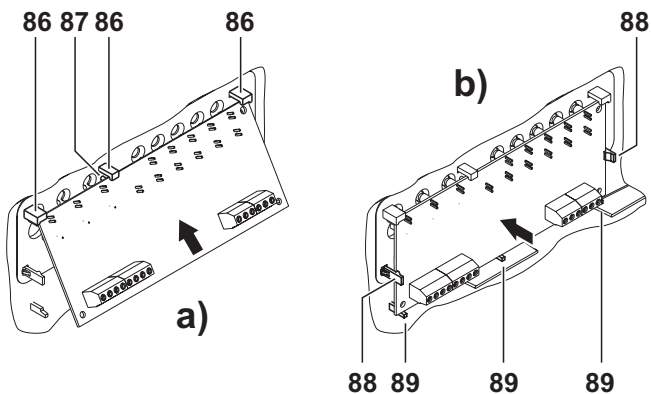

Figure 7 J408: Installing the Extinguishment Module

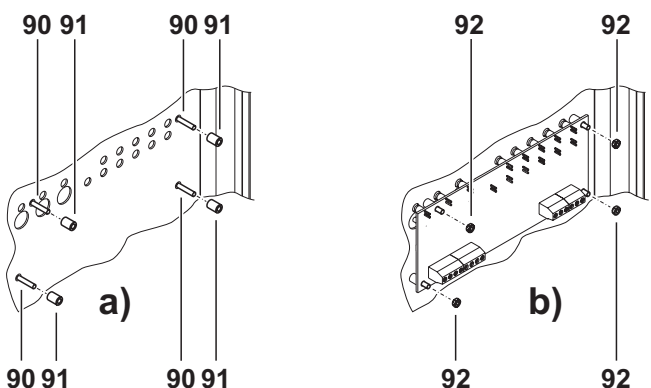

Figure 8 J424: Installing the Extinguishment Module

Installing accessory boards

! Ensure that the Control panel power supply (Mains and Batteries) has been disconnected before installing any accessory the Modules.

! Accessory Modules must be enrolled.

■ Installing Extinguishment Modules

J408 The J408 can house 1 Extinguishment Module, positioned as shown on page 14 (see part no. 28). To install the Extinguishment Module, work through the following steps.

1. Remove the screws 4 and open the Control panel.
2. Hold the unit with the component side facing you. Insert the Extinguishment Module under the clips 86 on the top part of the housing (see Figure 7a), then snap it gently into place. Ensure that it is resting properly on the plastic support pins 87 (see Figure 7a) and that it is held firmly in position by the clips 88 (as per Figure 7b).
3. Ensure that the Jumpers, marked "1" and "2" on the PCB (43 and 59 in the "Parts Description Table") are inserted (Extinguishment Module no. 1).
4. Using the Flat cable (27), connect the Extinguishment Module to the Main Board, via the jacks (58 and 63 respectively).
5. Place the label provided with the Extinguishment Module next to the data label that is already present on one of the Control panel's sides.

! The polarity of the Flat cable connectors must be observed.

J424 The J424 Control panel can house 2 Extinguishment Modules (28 and 31 in the Figure on page 12). Install the Extinguishment Module, as follows.

1. Remove the screws (4) and open the Control panel.
2. Fit the spacers (91) onto the plastic pins (90).
3. Using the nuts (93), secure the Extinguishment Module in position.

- Using the Jumper (43), marked "1" on the PCB, set up the Extinguishment Module address:
 Jumper (43) IN = Extinguishment Module nr. 1;
 Jumper (43) OUT = Extinguishment Module nr. 2.

👉 The Jumper (59), marked "2" on the PCB, MUST BE INSERTED.

- Using the Flat cables connect the Extinguishment Modules as follows:

if you are installing ONE Extinguishment Module — connect it to the Main Board, via the jacks (58 and 63 respectively), as per Fig. 9a;

if you are installing TWO Extinguishment Modules — connect Extinguishment Module nr. 1 to Extinguishment Module nr. 2, via the jacks (56) then, connect Extinguishment Module nr. 1 to the Main Board, via the jacks (58 and 63 respectively), as per Fig. 9b.

- Place the label provided with the Extinguishment Module next to the data label that is already present on one of the Control panel's sides.

👉 The polarity of the Flat cable connectors must be observed.

■ Installing Expander Module Kit (for J424 ONLY)

This Expander Module Kit comprises an 8 zone Expander Module and the Expander Control board. The Expander Module contains most of the electronic circuitry and electrical terminals whereas the Expander Control board provides the LEDs and control keys for Expander Module zones.

Install Expander Modules as follows:

- **if you are installing ONE Expander Module Kit**, mount the Expander Module (21) and the Expander Control board (10), as per Figure 11a;
- **if you are installing TWO Expander Module Kits**, mount Expander Module nr. 1 (21) and the Expander Control board (10) to the backplate then mount Expander Module nr. 2 (25) and the Expander Control board (7), as per Figure 11b.

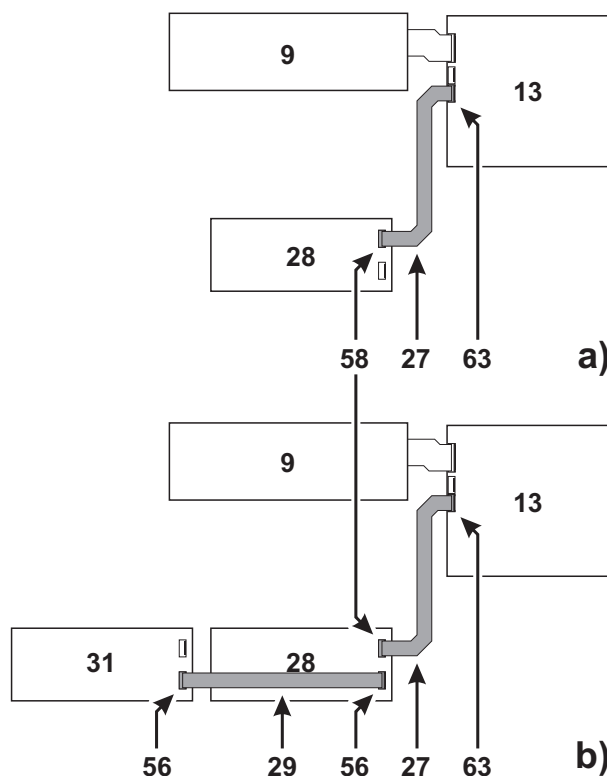

Figure 9 Connecting ONE Extinguishment Module (a) or TWO Extinguishment Modules (b) to a J424 Control panel: **9)** Main Control Board; **13)** Main Board; **27)** and **29)** Flat cable for the connection of the Extinguishment Modules; **28)** Extinguishment Module nr. 1; **31)** Extinguishment Module nr. 2; **56)** Jack for the connection to the consecutive Extinguishment Module; **58)** Jack for the connection to the Main Board; **63)** Jack for the connection of Extinguishment Module nr. 1.

👉 If you are installing ONE Expander Module Kit only, the location will be different to that shown in the diagram.

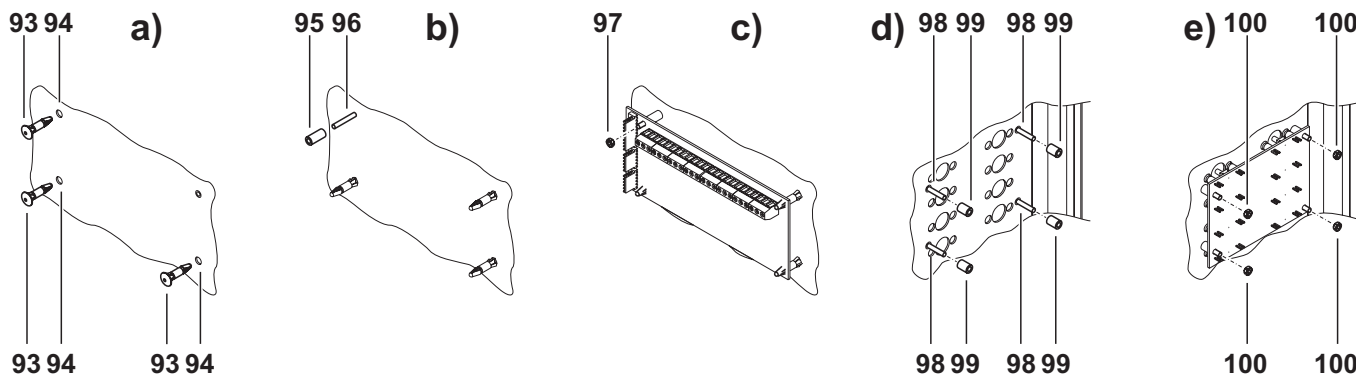



Figure 10 Installing an Expander Module Kit: **93)** Reverse locking supports; **94)** Expander Module anchor holes; **95)** Long plastic spacer; **96)** Expander Module placement screw; **97)** Expander Module nut; **98)** Expander Control Board screws; **99)** Short plastic spacer; **100)** Expander Control Board nut.

Expander Module Install Expander Modules as follows.

 *Expanders Modules must be installed before mounting the Control panel to the wall.*

1. Remove the screws (4) and open the Control panel.
2. Insert the reverse locking supports (93) into their respective locations (94) (as per Fig. 10a).
3. Fit the long spacer (95) onto the fixed screw (96), as shown in Fig. 10b.
4. Using a nut, secure the Expander Module in position (as per Fig. 10c).
5. Using the Jumper (70) set the Address of the Expander Module (marked "ADDR" on the PCB):
Jumper (70) IN = Expander Module nr. 1
Jumper (70) OUT = Expander Module nr. 2
6. Using the Flat cables connect the Expander Modules as follows:
7. **if you are installing ONE Expander Module** — connect it to the Main Board, via the jacks (84 and 64 respectively), as per Fig. 11);
if you are installing TWO Expander Modules — connect Expander Module nr. 1 to Expander Module nr. 2, via the jacks (83), then connect Expander Module nr. 1 to the Main Board, via the jacks (58 and 63 respectively), as per Fig. 11b.

 *The polarity of the Flat cable connectors must be observed.*

Expander Control Board Install the Expander Module as follows.

1. Fit the short spacers (99) onto the soldered screws (98), as shown in Fig. 10d.
2. Using the nuts, secure the Expander Control Board in position, as per Fig. 10e.
3. Using the Flat cable, connect the Expander Control Board to the respective Expander Module, via the jacks (72) and (8), as per Fig. 11a and Fig. 11b.

 *The polarity of the Flat cable connectors must be observed.*

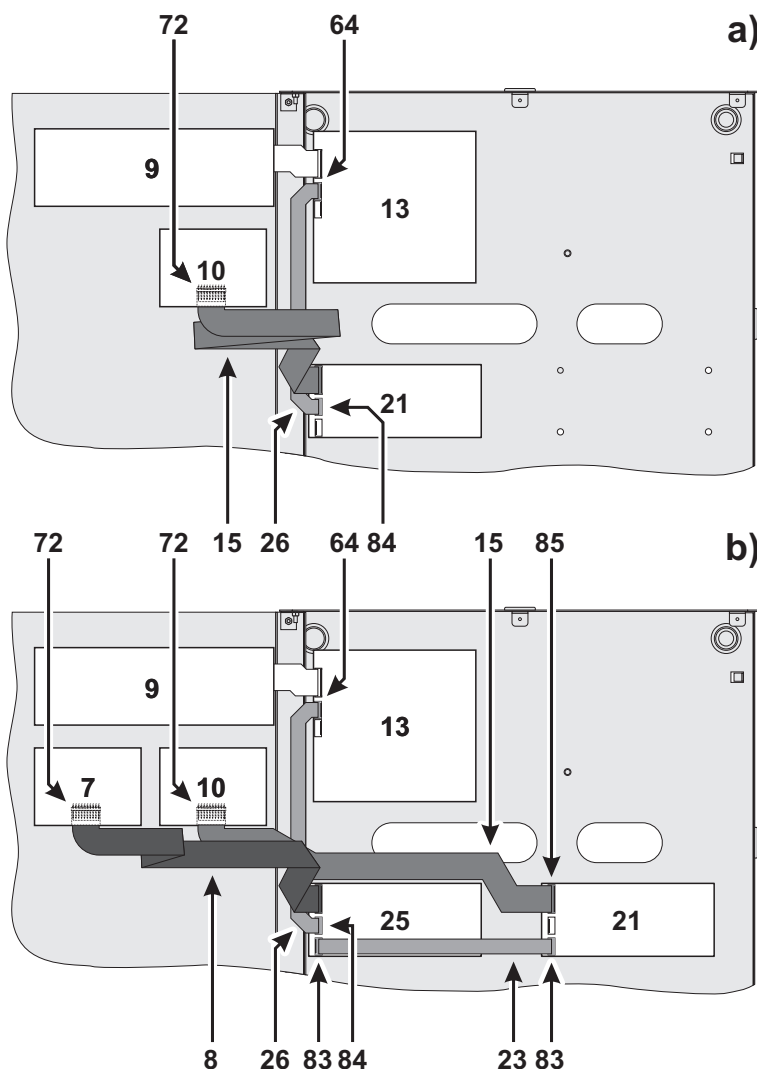

Figure 11 Connecting ONE Expander Module (a) Connecting TWO Expander Modules (b): **7)** Control Board of Expander Module nr. 2; **8)** and **15)** Flat cable for the connection between the Control Board and Expander Module; **9)** Main Control Board; **10)** Control Board of Expander Module nr. 1; **13)** Main Board; **21)** Expander Module nr. 1; **23)** and **26)** Flat cable for connection to the Expander Module; **25)** Expander Module nr. 2; **64)** Jack for the Expander Board connection; **72)** Jack for the connection between the Control Board and the respective Expander Module (on the component side); **83)** Jack for the connection between Expander Module nr. 1 and Expander Module nr. 2; **84)** Jack for the connection between the Expander Module and the Main Board; **85)** Jack for the Control Board connection.

■ Display Module (for J424 and J400-REP ONLY)

The J424 Control panel and the J400-REP Repeater both accept Display Modules (see 6 pages 12 and 16).

☞ *This instructions in the following section refer to the connection of an LCD Module to a J424 Control panel, the connection procedure for the J400-REP Repeater is similar.*

1. Remove the screws (4) and open the Control panel.
2. Remove the nuts (101), as per Fig. 12a.
3. Remove the protective film (108) from the glass plate (102), as per Fig. 12b.
4. Screw the brass tapped spacers (104) onto the fixed screws (103) and fit the plastic spacers (106) to the fixed screws (107), as per Fig. 12c.
5. Using the previously removed nuts (101), and those supplied with the display Module (105), secure the Display Module in position, as per Fig. 12d.
6. Using the Flat cable, connect the Display Module as follows:
 - J424: if NO Extinguishment Modules are installed** — connect the Display Module directly to the Main Board via the jacks (75 and 63 respectively), as per Fig. 13a;
 - J424: if ONE Extinguishment Modules is installed** — connect the Display Module to the Extinguishment Module via the jacks (75 and 56 respectively), as per Fig. 13b;
 - J424: if TWO Extinguishment Modules are installed** — connect the Display Module to Extinguishment Module nr. 2 via the jacks (75 and 58 respectively), as per Fig. 13c;
 - J400-REP:** connect the Display Module to the RS485 Interface via the jacks (75 and 63 respectively).

☞ *The polarity of the Flat cable connectors must be observed.*

7. Set the Display Module Address, as described in the “Display Module” section under “PROGRAMMING FROM THE CONTROL PANEL”

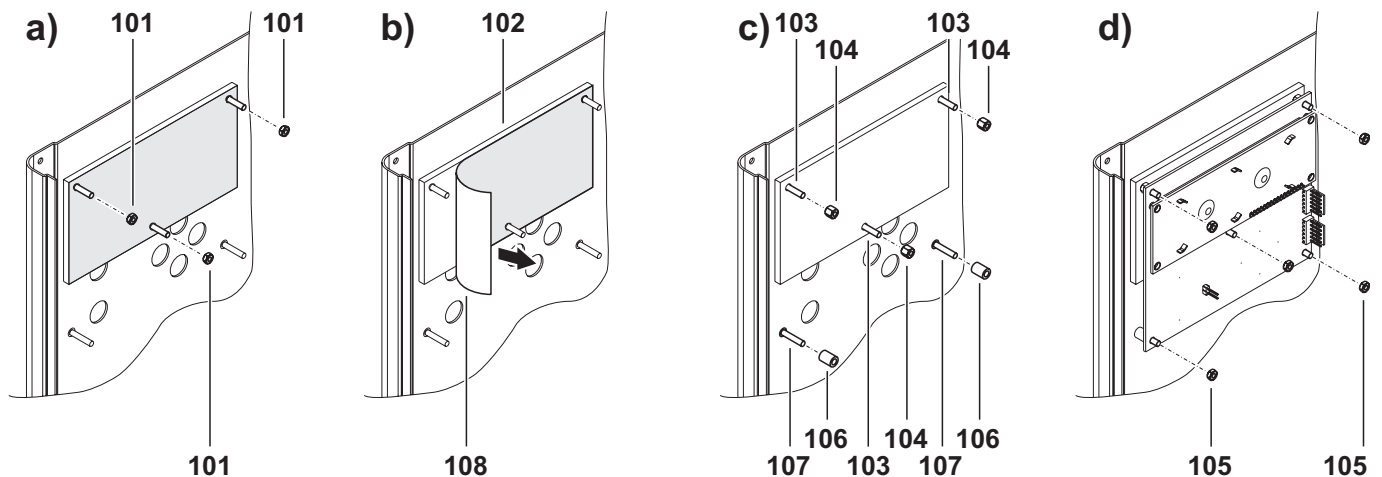

Figure 12 Installing the Display Module: **101)** and **105)** nuts; **102)** glass plate; **103)** and **107)** soldered screws; **104)** Brass tapped spacers; **106)** Plastic spacers; **108)** Protective film.

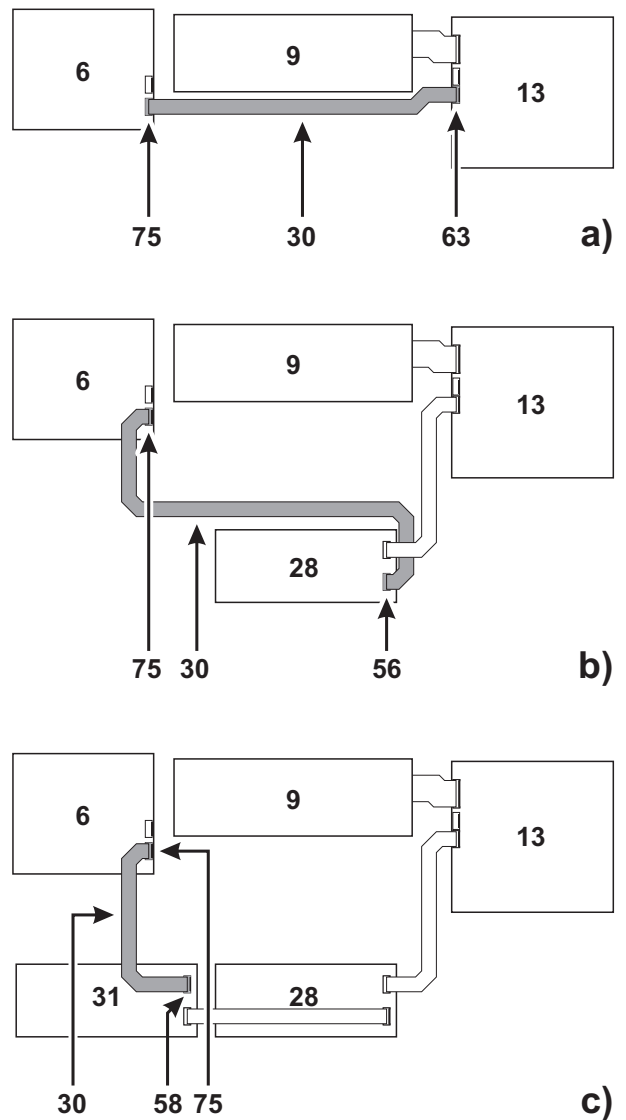



Figure 13 Connecting an LCD Module to a Control panel: **a)** without Extinguishment Modules; **b)** with ONE Extinguishment Module; **c)** with TWO Extinguishment Modules; **6)** Display Module; **9)** Main Control Board; **13)** Main Board; **28)** Extinguishment Module nr. 1; **30)** Flat cable for the Display Module connection; **31)** Extinguishment Module nr. 2.

Installing Repeaters

 *The Display Module (if used) must be installed before the Repeaters.*

Repeaters can be wall mounted, or flush mounted to an **ave® BL08** outlet box (or similar).

Work carefully through the following steps.

1. Lay the connection cables (refer to “Connecting Repeaters”).
2. Remove the screws (4) and open the Control panel.
3. Take out the bag 22 containing the Repeater panel Keys (Access Level 2).
4. If necessary, install the Display Module as described in the “Display Module” section.
5. If you are **flush mounting** the Repeater, go to step 7. If you are wall mounting the Repeater, drill the anchor screw holes 33.
6. Pull the wires through the wire entry 34, then, using the anchor screws, secure the Repeater to the wall.
7. Complete the connections to the terminal board 77 of the RS485 Interface (part nr. 35), as described in the “Connecting Repeaters” section.
8. Using the jumpers 76 of the RS485 (part nr. 35), set the Repeater Address, as per the following Table:

Repeater nr.	Jumpers 76	
	1	2
1	IN	IN
2	OUT	IN
3	IN	OUT
4	OUT	OUT

9. After power up, set the Address of the Display Module (if installed), as described in the “Display Module” section under “PROGRAMMING FROM THE CONTROL PANEL”.

Installing the Control panel

Work carefully through the following steps (see the Figures on pages 10, 12 and 14).

1. Remove the screws (4) and open the Control panel.
2. Drill the anchor screw holes 9.

 **Check for water pipes and electrical wiring before drilling.**

3. If necessary, using a hammer or similar tool, remove the surface conduit wire knockouts 1.

 *The cable conduit union with the case must be secured by **HB Flame Class** (or higher) lock nuts.*

4. Pull the wires through the chased wire entry 12 then, using the anchor screws, secure the backplate to the wall.

Description of the Terminals

This section describes the Control panel terminals.

■ Main Board and Expander Board terminals

[Z1] ... [Z8] Supervised/Bypassable detection zones. Detection device terminals for Fire detectors, Call points, Gas detectors, etc.

The Control panel will consider the zone:

- **Open** when the voltage is between **27.6 V** and **26.31 V**;
- **In Standby** when the voltage is between **26.31 V** and **17.15 V**;
- **In Alarm** when the voltage is between **17.15 V** and **2.82 V**;
- **Shorted** when the voltage is between **2.82 V** and **0 V**.

If the **Call point priority** option has been enabled (refer to “PROGRAMMING FROM A PC”), the Control panel will distinguish between Alarms generated by Detectors and Alarms generated by Manual Call Point, as follows:

- **Detector Alarm** — when the voltage is between **17.15 V** and **13.15 V**;
- **Call point Alarm** — when the voltage is between **13.15 V** and **2.82 V**.

The status thresholds can be programmed individually for each zone, in this way, it will be possible to compensate for voltage drops caused by the connections.

Up to 30 devices can be connected to each zone.

One 4-20 mA Gas detector can be connected to zone **Z1** of the Main Board and the Expander Module, as described in the “Connecting Gas Detectors” paragraph.

 *EN 54-2 certification applies ONLY when: no more than 30 devices are connected to each zone; no more than 3 Gas detectors are connected to the Control panel; no more than 512 devices IN ALL are connected to the Control panel.*

If a zone triggers an **Automatic Alarm** during **Day Mode**, the Control panel will initialize the **Pre-alarm** phase.

If a zone triggers an **Automatic Alarm** during **Night Mode**, the Control panel will generate an instant **Alarm**.

If a zone triggers a **Manual Alarm** — whether in **Day** or **Night Mode**, the Control panel will generate an instant **Alarm**.

If a zone **Shorts** or **Opens**, the Control panel will generate a **Trouble** warning.

Each **Reset** operation will interrupt the power supply to all zones for the programmed **Detector Reset Time**.

[R7] Detector negative

[R1] ... [R8] Silenceable/Repeat Outputs

Each zone provides a Repeat Output for selective intervention purposes (to close Fire doors, to limit signalling to the Zone concerned, etc.).

 *DO NOT connect EN54 “E”, “J” or “C” rated devices (visual, audible or telephone signalling devices) to Outputs **R1**, **R2**, ..., **R8**.*

Repeat Outputs are Normally Open.

Operating principles:

If the **Pre-Alarm on R Output** option is **DISABLED**, the Repeat Output of the zone in **Alarm** status will pull down to 0 V (negative) when the Control panel triggers **Alarm** status.

If the **Pre-Alarm on R Output** option is **ENABLED**, the Repeat Output of the zone in **Alarm** status will pull down to 0 V (negative) when the Control panel triggers **Pre-Alarm** status.

All the Repeat Outputs will restore to standby when the Control panel Resets.

 *If the **Gas Detector** option **ENABLED**, the Repeat Output of the zone will restore to standby when the Voltage on the zone terminal concerned drops below the Pre-Alarm threshold, that is, as long as the Alarm threshold value has not been exceeded in the meantime.*

If the **Non-Silenceable R Output** option is **DISABLED**, it will be possible to Silence (force to standby) the Repeat Output of the zone concerned.

Repeat Outputs will hold standby status for the programmed Silence Time.

If Alarm conditions are present when the Silence Time expires, the Repeat Output will re-activate.

Up to 0.1 A can circulate on each Repeat Output.

 *Outputs **R1**, **R2**, ..., **R8** accept devices that operate within **SELV** limits ONLY.*

■ Main Board Terminals

[24V] Auxiliary Power Supply

Power supply for devices that function at 24 V, protected by a resettable fuse, has battery backup.

Operating principles

➤ Positive pull-up to 27.6 V on the [24V] terminal;

➤ Negative pull-down to 0 V on the  terminal.

If the current draw on the [24V] terminal exceeds 1 A, the system will interrupt the power supply to the terminal and signal **Fault** on the **24V/24R** LED (fast blinking). The system will restore power to the terminal when the current draws drops below 1 A.

[24R] Resettable Auxiliary Power Supply

Resettable Power supply for devices that function at 24 V, protected by a resettable fuse, has battery backup.

Operating principles

➤ Positive pull-up to 27.6 V on the [24R] terminal;

➤ Negative pull-down to 0 V on the  terminal.

If the current draw on the [24R] terminal exceeds 1 A, the system will interrupt power to the terminal, and will signal **Fault** on the **24V/24R** LED (fast blinking). The system will restore power to the terminal when the current draws drops below 1 A.

The system will interrupt power from terminal [24R] during **Reset**, therefore, this power source can be used to power devices that reset when the power supply is interrupted.

OC Programmable Auxiliary Output

This Output can be programmed to signal one or more of the following events:

- Alarm
- Pre-alarm
- Fault
- Reset
- Disable
- Test
- Double Knock

 *DO NOT connect EN54 “E”, “J” or “C” rated devices (visual, audible or telephone signalling devices) to the **OC** output.*

The **OC** Output (Open-Collector) is Normally Open.

Operating principles:

This Output will activate when one of its associated events occurs, and will restore when the event ends.

Up to 1 A can circulate on the **OC** Output.

 *The **OC** Output accepts devices that operate within **SELV** limits ONLY.*

[DL] Supervised/Bypassable Dialler Output

This Output is for Dialler activation.

Operating principles

This Normally-Open Output (open-collector) will:

- pull down to 0 V (negative) when the **Alarm Signalling Delay** expires (refer to “DL Output” under “Outputs” in the “PROGRAMMING FROM A PC” section);
- restore to standby when the Control panel Resets.

Activation of the DL Output will be indicated by Glowing on the **Telecom LED**.

Short-circuit or power supply interruption on the DL Output will be indicated by fast blinking on the **Disab./Fault Telecom LED**.

The DL Output can be disabled by means of the **Disab./Fault Telecom** key. Disabling of the DL Output will be indicated by Glowing on the **Disab./Fault Telecom LED**.

If the DL Output is disabled, it will be unable to activate in the event of alarm.

Up to 0.1 A can circulate on the DL Output.

 *The DL Output accepts devices that operate within SELV limits ONLY.*

PL Power Loss Output

This Output is for Power loss signalling.

Operating principles

This Normally-Open Output will:

- pull down to 0 V (negative) in the event of total power failure (Mains and battery power supply);
- restore to standby when the power supply conditions return to normal.

Up to 1 A can circulate on the PL Output.

 *The PL Output accepts devices that operate within SELV limits ONLY.*

ALARM Silenceable Alarm Output

This Voltage free contact can be used for the connection of devices which cannot be connected directly to NAC1 or NAC2.

Operating principles:

- in Standby status, terminal [C] closes to terminal [NC];
- in the event of an Alarm, terminal [C] will close to terminal [NO], as per programming (refer to “ALARM Output” under “Outputs” in the “PROGRAMMING FROM A PC” section).

The ALARM Output will restore to standby when the Control panel resets.

 *DO NOT connect EN54 “E”, “J” or “C” rated devices (visual, audible or telephone signalling devices) to the ALARM Output.*

If the **NON-Silenceable** option of the ALARM Output has been DISABLED (refer to “ALARM Output” under “Outputs” in the “PROGRAMMING FROM A PC” section), it will be possible to Silence (force to standby) this Output.

The ALARM Output will hold standby status for the programmed Silence Time.

If Alarm conditions are present when the Silence Time expires, the ALARM Output will re-activate.

Up to 5 A can circulate on the ALARM Output.

 *The ALARM Output accepts devices that operate within SELV limits ONLY.*

TROUBLE Silenceable Trouble Output

This Output is for Trouble signalling.

Operating principles

- in Standby status, terminal [C] closes to terminal [NC];
- in Trouble status, terminal [C] will close to terminal [NO] (refer to “Trouble” in the “INTRODUCTION”).

 *DO NOT connect EN54 “E”, “J” or “C” rated devices (visual, audible or telephone signalling devices) to the TROUBLE output.*

Up to 5 A can circulate on the TROUBLE Output.

 *The TROUBLE Output will activate when the power supply to the Control panel fails (Mains and battery power supply). The TROUBLE Output accepts devices that operate within SELV limits ONLY.*

NAC1 and NAC2 Supervised/Silenceable/Bypassable Alarm Outputs

These Outputs are for the Alarm signalling devices.

Operating principles:

- in Standby status, these Outputs will be INACTIVE (read on for details);
- in Pre-Alarm status, these Outputs will ACTIVATE (read on for details) and DE-ACTIVATE in accordance with the programmed **Pre-Alarm Pattern** (refer to “NAC1” and “NAC2” under “Outputs” in the “PROGRAMMING FROM A PC” section);
- in Alarm status, these Outputs will ACTIVATE and DE-ACTIVATE in accordance with the programmed **Alarm Pattern** (refer to “NAC1” and “NAC2” under “Outputs” in the “PROGRAMMING FROM A PC” section).

Output INACTIVE: negative pull-down to 0 V on [+] terminal; positive pull-up to 27.6 V on the [-] terminal.

Output ACTIVE: positive pull-up to 27.6 V on the [+] terminal; negative pull-down to 0 V on the [-] terminal.

- NAC1 and NAC2 will restore to standby when the Control panel Resets.

If the “Bistable” option is enabled (refer to “Outputs” in the “PROGRAMMING FROM A PC” section), the NAC2 Output will return to standby when all zones return to standby.

- NAC1 and NAC2 can be Silenced (forced to standby). The NAC Outputs will hold standby status for the programmed Silence Time. If Alarm conditions are present when the programmed Silence Time expires, they will re-activate.

Short-circuit or power supply interruption on NAC1 or NAC2 will be indicated by fast blinking on the **Disab./Fault NAC LED**.

NAC1 and NAC2 can be disabled by means of the **Disab./Fault NAC** key.

Disabling of these Outputs will be indicated by Glowing on the **Disab./Fault NAC LED**.

If NAC1 and NAC2 are disabled, they will be unable to activate in the event of alarm.

Up to 1 A can circulate on NAC1 and NAC2.

☞ *NAC1 and NAC2 accept devices that operate within SELV limits ONLY.*

■ Extinguishment Module Terminals

EM Supervised/Bypassable Manual Extinguishment Input

This Input is for manual activation of the Fire Extinguishment systems.

Standby status of this Input can be either **Normally Open** (at default) or **Normally Closed** (refer to “Manual Extinguishment Input” under “Enrolling: Extinguishment Modules” in the “PROGRAMMING FROM PC”)

Operating principles:

- the Control panel will consider the EM Input OPEN when a 3.900 ohm resistance is applied to its [+] and [-] terminals;
- the Control panel will consider the EM Input CLOSED when one or more (up to 10) 680 ohm resistor is/are applied in parallel to the 3.900 ohm resistance.

The EM Input will activate when inverse conditions to its standby conditions occur.

Activation of the EM Input will start the Pre-Extinguishment Time.

Activation of the EM Input will be indicated by Glowing on the **ON Manual Ext.** LED.

Short-circuit or power supply interruption on the EM Input will be indicated by fast blinking on the **Fault Manual Ext.** LED.

The EM input can be disabled by means of the **Disable Manual Extinguish.** key.

Disablement of this Input will be indicated by Glowing on the **Disable Manual Extinguish.** LED.

IE Supervised Inhibit Extinguishment Input

This Input is for the inhibition of Fire Extinguishment systems.

The standby status of this Input can be either **Normally Open** (at default) or **Normally Closed** (refer to “Disable Extinguishment Input” under “Enrolling: Extinguishment Modules” in the “PROGRAMMING FROM A PC”).

Operating principles:

- the Control panel will consider the IE Input OPEN when a 3.900 ohm resistor is applied between its [+] and [-] terminals;
- the Control panel will consider the IE Input CLOSED when one or more (up to 10) 680 ohm resistor is/are applied in parallel to the 3.900 ohm resistor.

The IE Input will activate when the inverse conditions to its programmed standby conditions occur.

If the IE Input is active when Extinguishment conditions occur, the Control panel will activate the PR Output (Pre-Extinguishment) and WILL START the Pre-Extinguishment Time.

If the IE Input activates during the Pre-Extinguishment phase, the Control panel WILL NOT STOP the Pre-Extinguishment Time.

In both cases, when the time has elapsed, no extinguishment will occur unless the IE Input is restored to stand-by. If the IE Input is activated during the Extinguishment phase, this will have no effect.

Activation of the IE Input will be indicated by Glowing on the **ON Disab. Ext.** LED.

Short-circuit or power supply interruption on the IE Input will be indicated by fast blinking on the **Fault Disab. Ext.** LED.

PS Supervised Pressure Switch Input

This Input is for the Pressure Switch connection.

Standby status of this Input can be either **Normally Open** (at default) or **Normally Closed** (refer to “Pressure Switch Input” under “Enrolling: Extinguishment Modules” in the “PROGRAMMING FROM A PC”).

- the Control panel will consider the PS Input OPEN when a 3.900 ohm resistor is applied across its [+] and [-] terminals;
- the Control panel will consider the PS Input CLOSED when one or more (up to 10) 680 ohm resistor is/are applied in parallel to the 3.900 ohm resistor.

The PS Input will activate when the inverse conditions to its programmed standby conditions occur.

Activation of the PS Input will be indicated by Glowing on the **ON Pres. Switch** LED. Short-circuit or power supply interruption on the PS Input will be indicated by fast blinking on the **Fault Pres. Switch** LED.

Short-circuit or power supply interruption on the PS Input will be indicated by fast blinking on the **Fault Pres. Switch** LED.

EV Supervised Electrovalve Output

This Output is for the Electrovalve connection.

Operating principles:

- in Standby status, the EV terminals will be OPEN;
- during the Extinguishment phase, the EV terminals will be CLOSED.

Activation of the EV Output will be indicated by Glowing on the **ON Electrovalve** LED. Short-circuit or power supply interruption on the EV Output will be indicated by fast blinking on the **Fault Electrovalve** LED.

Up to 5 A can circulate on the EV Output.

☞ *This Output is not enabled if there is a fault with the IE Input and/or the PR Output.*

24P Power Boost Input

This Input is for the Power boost required by the devices connected to Outputs PR and AE.

Wiring instructions:

Connect the [+] and [-] terminals of this Input to the [+] and [-] terminals **47** of the Switching Power Supply.

PR Supervised/Silenceable Pre-Extinguishment Output

This Output is for Pre-Extinguishment signalling.

Operating principles

- Standby status: negative pull-down to 0 V on the [+] terminal; positive pull-up to 27.6 V on the [-] terminal.
- Pre-Extinguishment phase: positive pull-up to 27.6 V on the [+] terminal; negative pull-down to 0 V on the [-] terminal.

Activation of the PR Output will be indicated by Glowing on the **ON Pre Ext.** LED.

Short-circuit or power supply interruption on the PR Input will be indicated by fast blinking on the **Fault Pre Ext.** LED.

Up to 1 A can circulate on the PR Output.

CONVENTIONAL FIRE PANELS

J424



J408



USER'S INSTRUCTIONS



Standby status

During normal operating conditions (Standby status), ONLY the green Mains LED and, if the Control panel is operating in Night Mode, the **Night Mode** LED will be On (glowing). The display will show the time and date and "PANEL WORKING" message:



```
PANEL WORKING
17:30 13/10/2004
```

PRE-ALARM

If a fire detector goes into alarm during **DAY Mode**, the Control panel will trigger the PRE-ALARM phase which will be signalled by:

- the respective signalling devices;
- the **Pre-al.** LED (On);
- the **Zone Alarm** LEDs of the zones concerned (glowing);
- an intermittent audible signal (0.5 second beep followed by a 0.5 second pause);
- a message, similar to the following:

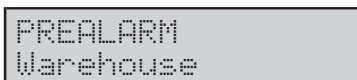

```
PREALARM
Warehouse
```

The bottom line on the display will show the label (e.g Warehouse) of the zone that triggered the PRE-ALARM.

During PRE-ALARM status, you can:

Use ∇ or \blacktriangle to scroll the zones concerned.

If you do not press a button within 20 seconds, the display will go back to the first zone that triggered the PRE-ALARM.

Press **Esc** to access the Main menu.

If you do not press a button within 20 seconds, the display will go back to the first zone that triggered the PRE-ALARM.

PRE-ALARM status will last for the pre-set Time (refer to the following paragraph for details).

 *The Control panel will generate an instant Alarm (refer to "Night Mode"), if alarm conditions are detected during **Night Mode** or, if an alarm is triggered from a Manual Call point — connected to a zone with the **Call point priority** attribute (i.e. **Call point priority ENABLED**).*

ALARM

ALARM status will be signalled by:

- the respective signalling devices;
- the **Alarm** LED (On);
- the **Zone Alarm** LEDs of the zones concerned (glowing);

- a fast intermittent audible signal (0.2 second beep followed by a 0.2 second pause);
- an "ALARM" message, similar to the following:



```
ALARM ON ZONE 01
Warehouse
```

The top line of the display will show the number of the zone that triggered the ALARM, and the bottom line will show the zone label (e.g Warehouse).

During ALARM status, you can:

Use ∇ or \blacktriangle to scroll the zones concerned.

If you do not press a button within 20 seconds, the display will go back to the first zone that triggered the ALARM.

Press **Esc** to view the Main menu.

If you do not press a button within 20 seconds, the display will go back to first zone that triggered the ALARM.

If zones restore to standby spontaneously, the ALARM events will be stored in the Memory and signalled on the respective **Zone Alarm** LEDs until you Reset the Control panel.

 *The Fire Alarm Outputs will not restore to standby until you Reset the Control panel — even if an Alarm ends spontaneously.*

FAULT

FAULTS will be signalled by:

- the respective signalling devices;
- the **Fault** LED (On);
- the respective **Fault** LED (On) — refer to Table 1;
- a slow intermittent audible signal (1 second beep followed by a 1 second pause);
- a message on the display, similar to the following (refer to Table 1):



```
FAULT ON ZONE 01
Warehouse
```

If FAULT conditions are detected, you can:

Use ∇ or \blacktriangle to scroll the Faults list.

If you do not press a button within 20 seconds, the display will go back to the first fault that occurred.

Press **Esc** to view the Main Menu.

If you do not press a button within 20 seconds, the display will go back to first FAULT that occurred.

If FAULT conditions clear spontaneously, the respective events will be stored in the Memory, and will be signalled by slow flashing on the respective LEDs.

 *The Control panel will restore to standby when all the FAULT conditions clear.*

LED	STAT.	DISPLAY	DESCRIPTION	CONSEQUENCE
Disabled /Fault /Test	Fast blink.	FAULT ON ZONE 01 Warehouse	A detector is missing from zone no. 1, or zone no. 1 is shorted or open	The detectors downstream of the missing detector will be unable to signal fire conditions
Logic Unit	ON		The Control panel is blocked	The Control panel will be unable to function
Mains (amber)	Fast blink.	FAULT Main Fault.	The Control panel is NOT powered from the Mains	The batteries will provide power until they empty.
Disab./Fault Telecom	Fast blink.	FAULT DL Output	The Dialler Output is shorted or open	The Telephone devices set up to send fire warnings will be unable to function
Ground	ON	FAULT Ground Fault.	Leakage to Earth	The Control panel functions may be impaired
24V/24R	Fast blink.	FAULT 24V Output	24V Output is shorted	The devices connected to the 24V Output will be unable to function
		FAULT 24R Output	24R Output is shorted	The devices connected to the 24R Output will be unable to function
Battery	Fast blink.	FAULT Battery	The Control panel batteries are empty, faulty or disconnected	The Panel may be unable to function in the event of black-out
Disab./Fault NAC	Fast blink.	FAULT NAC 1 Output.	The NAC1 Output is shorted or open	The devices connected to the NAC1 will be unable to function
		FAULT NAC 2 Output.	The NAC2 Output is shorted or open	The devices connected to the NAC2 will be unable to function
Periph.	Fast blink.	FAULT Peripheral	The Panel CANNOT communicate with the peripherals	The Panel will be unable to read the status of the Peripherals
<i>The information in the following rows is valid for Extinguishment Module nr. 1 and Extinguishment Module n. 2</i>				
Fault: Electro-valve	Fast blink.	FAULT ON EXT. 1 ELECTROVALVE	The power supply to the Electrovalve is interrupted or the Electrovalve Output is shorted or open	The Fire Extinguishment systems CANNOT be activated
Fault: Pre Ext.	Fast blink.	FAULT ON EXT. 1 PRE-EXT. OUTPUT	The Pre-extinguishment Output is shorted or open	The Panel will be unable to signal the Pre-extinguishment phase
Fault: Manual Ext.	Fast blink.	FAULT ON EXT. 1 MANUAL EXT.INPUT	Manual Extinguishment Input is shorted or open	The Manual Extinguishment buttons CANNOT activate the Extinguishment phase
Fault: Disab. Ext.	Fast blink.	FAULT ON EXT. 1 INHIB.EXT.INPUT	The Inhibit Extinguishment Input is shorted or open	The Inhibit Extinguishment buttons CANNOT inhibit the Extinguishment phase
Fault: Pres. Switch	Fast blink.	FAULT ON EXT. 1 PRES.SWITCH INP.	The Pressure switch Input is shorted or open	The Panel will be unable to gauge the Extinguishment Gas pressure
Fault: Logic Unit	ON		The Extinguishment Module is blocked	The Extinguishment Module will be unable to function
<i>The information in the following rows is valid for all the Power Supply Stations</i>				
		FAULT POWER ST.1 Main Fault	The Power Supply Station is not powered from the Mains	The batteries will supply the Power Supply Station until they empty
		FAULT POWER ST.1 Low Battery	The Power Supply Station batteries are low	The Power Supply Station may be unable to function in the event of black-out
		FAULT POWER ST.1 Battery Fault	The Power Supply Station batteries are low or disconnected	The Power Supply Station may be unable to function in the event of black-out
		FAULT POWER ST.1 Battery Disconn.	The batteries of the Power Supply Station has shutdown due to voltage drop	The Power Supply Station may be unable to function in the event of black-out
		FAULT POWER ST.1 OUT 1	The Output nr. 1 of the Power Supply Station is shorted	The devices connected to the Output 1 will be unable to function
		FAULT POWER ST.1 OUT 2	The Output nr. 2 of the Power Supply Station is shorted	The devices connected to the Output 2 will be unable to function

Table 1 Fault Descriptions

Access Level 2

Most of the functions provided by this Control panel are available at Access Level 2. Therefore, only **Key** and **PIN Code Users** can operate the system (PIN Code entered or Key turned in the Keyswitch).

Accessing Level 2 using a Key Insert the key into the Keyswitch and turn it horizontally — access will be indicated by a beep.

To exit Access Level 2: turn the key back and remove it from the Keyswitch — the Control panel will hold Access Level 2 for a further 20 seconds then will emit two beeps to indicate the end of Access Level 2 status.

Accessing Level 2 using a PIN Code Type in your PIN Code (**1234** at Default): — access will be indicated by a five beeps in rapid succession.

To exit Access Level 2: DO NOT press any button for 20 seconds: the end of Access Level 2 status will be indicated by two beeps in rapid succession.

Investigation Time (Ack./Evac. button)

The **Ack./Evac.** button will allow you to extend the pre-set Pre-alarm Time.

If you press **Ack./Evac.** button, the Pre-alarm Time will be replenished with the pre-set Investigation Time.

 *The **Ack./Evac.** button functions only during the Pre-alarm phase (**Pre-al.** LED ON).*

To activate the **Investigation Time** phase:

1. Enter the PIN Code or turn the key in the Keyswitch (Access Level 2).
2. Press and hold the **Ack./Evac.** button **for at least 5 seconds**: the **Ack./Evac.** LED will go On to indicate that the Investigation Time is running.

 *You can request Investigation Time once only.*

Evacuation (Ack./Evac. button)

You can also use the **Ack./Evac.** button to activate an Evacuation Alarm.

To activate an ALARM when the Control panel is in **Pre-alarm** status (**Pre-al.** LED ON), press and hold the **Ack./Evac.** button **AT LEAST 5 seconds**.

To activate an Alarm when the Control panel is in **Standby** status:

1. Enter the PIN Code or turn the key in the Keyswitch (Access Level 2).
2. Press the **Ack./Evac.** button **for at least 5 seconds**.

Silence

The **Silence** button will allow you to stop the signalling devices. To Silence the signalling devices:

1. Enter the PIN Code or turn the key in the Keyswitch (Access Level 2).
2. Press **Silence**.

Disable

If a detector is not working properly or is causing false Alarms (signalled by fast blinking on the **Disabled/Fault/Test** LED), you can disable it by pressing the respective zone button. You can disable signalling devices (Bells, Sirens, Fire signs, etc.) by pressing the **Disab./Fault NAC** button, and disable the Dialler output by pressing the **Disab./Fault Telecom** Button.

 *Disabled devices will be unable to work in the event of fire.*

Reset

The **Reset** button will allow you to Reset the Control panel (stop the signalling devices, reset detectors and clear the memory). To Reset the Control panel:

1. Enter the PIN Code or turn the key in the Keyswitch (Access Level 2).
2. Press **Reset**.

 *To **Reset** the Control panel after an ALARM, first press the **Silence** button.*

Test

The Test button will allow you to check the working order of the Control panel LEDs and Buzzer.

Extinguishment Module

This Control panel is equipped with an Extinguishment Module for fire extinguishment purposes (up to 2 Extinguishment Modules can be connected to J424 Control panels). These devices have been specially designed to reduce unnecessary activation of Fire Extinguishment appliances.

In the event of a Fire, the Extinguishment systems will be activated when the pre-set **Pre-Extinguishment** Time expires. These devices can also be activated from manual call-points (ask your Installer for details).

Extinguishment systems may also be activated using one of the buttons provided by the installer. In this case, a different Pre-Extinguishment time may be set (refer to the Programming from a PC section).

■ Pre-extinguishment Phase

If the programmed extinguishment conditions occur (programmed by your Installer), the Extinguishment Module will generate the Pre-extinguishment phase which will be signalled by:

- the respective signalling devices;
- the **ON Pre Ext.** LED (On).
- buzzer.

The Extinguishment Module will activate the Fire Extinguishment systems when the Pre-extinguishment Time expires.

The Pre-extinguishment phase will allow you to check whether use of Fire Extinguishment systems, and Evacuation of the premises are really necessary.

You can end this phase by pressing:

- any "Stop Extinguishment" button (set up by your Installer).

In this case, the Pre-Extinguishment Time will NOT be stopped by the Control panel. When the time has elapsed, no extinguishment will occur unless the IE Input is restored to standby.

☞ *The **Disable Extinguish.** button can be used during Access Level 2 only.*

■ Extinguishment Phase

The Extinguishment Module will activate the Fire Extinguishment systems when the Pre-extinguishment Phase expires.

The Extinguishment Phase will be signalled by:

- the **ON Electrovalve** LED (On).
- the devices provided by the installer.
- buzzer.

The **AV ACTIVATED** event, and the respective details will be recorded in the logger (**EXTING.MODULE 1** or **EXTING.MODULE 2**).

The Extinguishment Phase will run for the pre-set Extinguishment Time or until the Control panel Resets.

■ Manual Extinguishment

The Extinguishment Module can be activated from manual call-points (ask your Installer for details).

Manual activation of the Extinguishment Module is signalled by:

- the **ON Manual Ext.** LED (On);
- a message on the display similar to the following:



```
EXTING.MODULE.1
MANUAL ACTIVATE
```

- buzzer.

☞ *If you activate the Extinguishment Module manually, the Control panel will generate an Alarm.*

☞ *Pre-Extinguishment and Extinguishment will NOT be carried out by the Control panel in the event of a fault on the PR Output or the IE Output.*

■ Disable Extinguish. button

This button will allow you to inhibit the Fire Extinguishment systems.

☞ *The **Disable Extinguish.** button can be used during Access Level 2 only.*

This operation will be signalled by:

- the **Disable Extinguish.** LED (On);
- the **Disab.** LED (On).

The **OUTS BYPASS** event, and respective details will be recorded in the logger (**EXTING.MODULE 1** or **EXTING.MODULE 2**).

If you disable the Extinguishment Module during Standby status, it will be unable to operate in the event of an Alarm.

■ Disable Manual Extinguish. button

This button will allow you to Disable/Enable manual activation of the Extinguishment Module.

☞ *The **Disable Manual Extinguish.** button can be used during Access Level 2 only.*

This operation will be signalled by:

- the **Disable Manual Extinguish.** LED (On);
- the **Disab.** LED (On).

■ Disable Automatic Extinguishment

This button will allow you to Disable/Enable the activation of extinguishment, via the detectors provided by the installer.

☞ *The **Disable Automatic Extinguish.** button can be used during Access Level 2 only.*

This operation will be signalled by:

- the **Disable Automatic Extinguish.** LED (On);
- the **Disab.** LED (On).

EVENTS	DETAILS	DESCRIPTION
24R OUT FAULT	None	24R output is shorted
24R OUT RESTORE	None	24R output has been restored
24V OUT FAULT	None	24V output is shorted
24V OUT RESTORE	None	24V output has been restored
ALARM ZONE	Zone no. + Description	The zone concerned is in Alarm status
AUTO UNBYPASSED	Extinguishment Mod. nr.	Automatic Extinguishment of Ext. Mod. nr. has been re-enabled
BATT. CHARG. FAULT	Power Supply Stat. nr.	Charger of Power Supply Stat. nr. not working properly
BATT. CHARG. REST.	Power Supply Stat. nr.	Charger of Power Supply Stat. nr. has been restored
BATTERY DISCONN.	Power Supply Stat. nr.	Batteries of Power Supply Stat. nr. disconnected
BATTERY FAULT	None	Panel batteries empty, malfunctioning or disconnected
BATTERY FAULT	Power Supply Stat. nr.	Batteries of Power Supply Stat. nr. empty or disconnected
BATTERY FAULT	Power Supply Stat. nr.	Batteries of Power Supply Stat. nr. low
BATTERY RECONN.	Power Supply Stat. nr.	Batteries of Power Supply Stat. nr. have been restored
BATTERY RESTORE	Power Supply Stat. nr.	Batteries of Power Supply Stat. nr have been restored
BATTERY RESTORE	None	Panel batteries have been restored
BATTERY RESTORE	Power Supply Stat. nr.	Batteries of Power Supply Stat. nr. empty or disconnected
BUZZER SILENCED	None	The Buzzer has been disabled
BYPASSED ZONE	Zone no. + Description	The zone concerned has been disabled
DETECTOR MISSING	Zone no. + Description	The detector connected to the zone concerned is not working
DIALLER ACTIVATE	None	Dialler Output has been activated
DISAB. AUTO	Extinguishment Mod. nr.	Automatic Extinguishment of Ext. Mod. nr. has been disabled
DL OUT FAULT	None	Dialler connections interrupted or shorted
DL OUT RESTORE	None	Dialler connections has been restored
DL OUTPUT	Enabled/Disabled	The Dialler Output has been disabled/enabled
EM ACTIVATED	Extinguishment Mod. nr.	EM Input of Extinguishment Mod. nr. has been activated
EM INPUT FAULT	Extinguishment Mod. nr.	EM Input of Extinguishment Mod. nr. shorted or open
EM INPUT RESTORE	Extinguishment Mod. nr.	EM Input of Extinguishment Mod. nr. has been restored
EV OUT ACTIVATED	Extinguishment Mod. nr.	EV Output of Extinguishment Mod. nr. has been activated
EV OUT FAULT	Extinguishment Mod. nr.	EV Output of Extinguishment Mod. nr. shorted or open
EV OUT RESTORE	Extinguishment Mod. nr.	EV Output of Extinguish. Mod. nr. has been restored
EVACUATE	None	Evacuation command executed
GND FAULT REST.	None	Control panel ground fault has been restored
GROUND FAULT	None	Control panel leakage to Earth
IE ACTIVATED	Extinguishment Mod. nr.	IE Input of Extinguishment Mod. nr. has been activated
IE INPUT FAULT	Extinguishment Mod. nr.	IE Input of Extinguishment Mod. nr. shorted or open
IE INPUT RESTORE	Extinguishment Mod. nr.	IE Input of Extinguishment Mod. nr. has been restored
INVESTIGATION	None	Investigation executed
MAIN FAULT	None/Pow.SupStat.nr.	Mains failure to Control panel/Power Supply Stat. nr.
MAIN RESTORE	None	The Control panel/Power Supply Stat. nr. powered from Mains
MANUAL BYPASSED	Extinguishment Mod. nr.	EM Input of Extinguishment Mod. nr. has been disabled
MANUAL UNBYPASS.	Extinguishment Mod. nr.	EM Input of Extinguishment Mod. nr has been re-enabled
MODE	Night/Day	Control panel has switched from Night to Day Mode
NAC OUTPUT	Enabled/Disabled	One of the Alarm outputs has been disabled/enabled
NAC1 FAULT	None	Alarm device connections interrupted or shorted
NAC1 RESTORE	None	Alarm device connections interrupted has been restored
NAC2 FAULT	None	Alarm device connections interrupted or shorted
NAC2 RESTORE	None	Alarm device connections interrupted has been restored
OUT 1 RESTORE	Power Supply Stat. nr.	O1 Output of Power Supply Stat. nr has been restored
OUT 1 SHORT	Power Supply Stat. nr.	O1 Output of Power Supply Stat. nr shorted
OUT 2 RESTORE	Power Supply Stat. nr.	O2 Output of Power Supply Stat. nr has been restored
OUT 2 SHORT	Power Supply Stat. nr.	O2 Output of Power Supply Stat. nr shorted
OUTS BYPASSED	Extinguishment Mod. nr.	Extinguishment Mod. PR, EV and AV outputs disabled
OUTS UNBYPASSED	Extinguishment Mod. nr.	Extinguishment Mod. PR, EV and AV outputs re-enabled
PR OUT ACTIVATED	Extinguishment Mod. nr.	PR Output of Extinguishment Mod. nr. activated
PR OUT FAULT	Extinguishment Mod. nr.	PR Output of Extinguishment Mod. nr. shorted or open
PERIPHERAL FAULT	Peripheral type and nr.	The device concerned is missing or faulty
PERIPHERAL REST.	Extinguishment Mod. nr.	PR Output of Extinguish. Mod. nr. has been restored
PERIPHERAL REST.	Device type+Number	The device concerned has been restored

Table 2 Event Descriptions (Continues ...): **AV** = Extinguishment Done; **EM** = Manual Extinguishment; **EV** = Electro-valve; **IE** = Inhibit Extinguishment ; **PR** = Pre-extinguishment; **PS** = Pressure switch.

EVENTS	DETAILS	DESCRIPTION
PS ACTIVATED	Extinguishment Mod. nr.	PS Input of Extinguishment Mod. nr. is operating
PS INPUT FAULT	Extinguishment Mod. nr.	PS Input of Extinguishment Mod. nr. shorted or open
PS INPUT RESTORE	Extinguishment Mod. nr.	PS Input of Extinguish. Mod. nr. executed
RESET	None	Reset executed
RESTORE	Zone no. + Description	The detector of the Zone concerned has been restored
SILENCED	None	Silence executed
SWITCH.DISCONN.	Power Supply Stat. nr.	Switching Power Supply of Station nr. is disconnected
SWITCH.RECONN.	Power Supply Stat. nr.	Switching Power Supply of Station nr. has been restored
UNBYPAS.ZONE	Zone no. + Description	The Zone concerned has been re-enabled
ZONE FAULT REST.	Zone no. + Description	The Zone concerned has been restored
ZONE OPEN	Zone no. + Description	The Zone concerned is open
ZONE PREALARM	Zone no. + Description	The Zone concerned is in Pre-alarm status
ZONE SHORT	Zone no. + Description	The Zone concerned is shorted

Table 2 Event Descriptions: **AV** = Extinguishment Done; **EM** = Manual Extinguishment; **EV** = Electrovalve; **IE** = Inhibit Extinguishment ; **PR** = Pre-extinguishment; **PS** = Pressure switch.

The Logger

The Control panel logger can store the Time, Date and Details of 50 events. To view the events in the logger, proceed as follows.

- From standby status, use ∇ or \blacktriangle to view the **LOGGER**:

```
VIEW
LOGGER
```

- Press **Esc** to step back or, press **Enter** to view the last event in the Logger.

```
ALARM  ZONE
15:46  18/10/2004
```

The top line on the display will show the event (refer to the **DESCRIPTIONS** column in Table 2), the bottom line will show when the event occurred (Time and Date).

- Use ∇ or \blacktriangle to scroll up and down the event list, use \blacktriangleright to view the event details (see the **DETAILS** column in Table 2).

```
ZONE 01
Warehouse
```

- Repeat the previous step to continue viewing or, press **Esc** to step back.

The Status LEDs

This section describes the warnings signalled on the Control panel LEDs and actions that can be taken during the various phases of a fire alarm.

- Some LEDs indicate more than one status and, if not otherwise stated, operate as follows:
 - ON** (glowing) indicates **DISABLED** status;
 - Fast blinking** indicates a **FAULT** condition;
 - Slow blinking** indicates an **ALARM/FAULT** event in memory.

Mains (Green) Under normal operating conditions this LED will be On (glowing). This LED indicates the presence of the **MAINS POWER SUPPLY**.

Alarm On (glowing) indicates that at least one zone is in **ALARM** status (the zones in **ALARM** status can be viewed on the **Zone Alarm** LEDs). During **ALARM** status, **Key** and **PIN Code users (Access Level 2** — refer to “Access Level 2”) will be able to:

- STOP the Silenceable Alarm signalling by pressing the **Silence** button;
- STOP the entire **ALARM** procedure (in the event of false alarm) by pressing the **Reset** button.

- The **Silence** and **Reset** buttons can be used during **Access Level 2** only.

Pre-al. On (glowing) indicates **PRE-ALARM** status. The Control panel will generate an **ALARM** when the pre-set **PRE-ALARM** time expires. During **PRE-ALARM** status, **Key** and **PIN Code users (Access Level 2** — refer to “Access Level 2”) will be able to:

- EXTEND the Pre-alarm Time (to allow Alarm verification) by pressing the **Ack./Evac.** button for **LESS THAN 5 seconds**;
- ACTIVATE an Evacuation Alarm by pressing and holding the **Ack./Evac.** key for **AT LEAST 5 seconds**;
- STOP the Silenceable Alarm signalling and interrupt the Pre-alarm Time by pressing the **Silence** button;
- STOP the **ALARM** procedure (in the event of false alarm) by pressing the **Reset** button.
- STOP Fire Extinguishment systems (e.g. Sprinkler system, etc.) by pressing the **Disable Extinguish.** button on the Control panel or, any **Disable Extinguish.** button located on the premises.

 **The Ack./Evac., Silence and Reset buttons can be used during Access Level 2 only.**

Test ON (glowing) indicates that at least one Zone is in Test status. The zones in Test status can be viewed on the **Disabled/Fault/Test** LEDs.

Disab. ON (glowing) indicates that at least one zone has been DISABLED, therefore, it will be unable to trigger ALARMS. The DISABLED zones can be viewed on the **Zone Alarm** LEDs.

Telecom ON (glowing) indicates that the Dialler has been activated.

Mains (GREEN) OFF indicates Mains failure. Mains failure may be due to local black-out in the area, if this is not the case, you must call your installer for service. **IMPORTANT:** The Control panel will be powered by the batteries during black-out, however, if Mains failure lasts for many hours the batteries may empty.

Fault ON (glowing) indicates that one or more faults have been detected. The Fault types can be viewed on the respective LEDs.

Logic Unit ON (glowing) indicates that the Control panel is blocked. Call your installer for service.

24V/24R Fast blinking indicates short-circuit. Call your installer for service.

Battery ON (glowing) indicates that the batteries are low or disconnected, therefore, in the event of a black-out will be unable to power the Control panel. Allow the batteries to recharge for several hours, if the condition continues, you must call your installer for service.

Ground ON (glowing) indicates a Ground fault. Call your installer for service.

Periph. Fast blinking indicates communication trouble with the peripherals (Expander module, Extinguishment module, LCD Module, Repeater panel, Power station),. Call your installer for service.

Mains (Amber) Normally Off. This LED will switch **On** in the event of **Mains Failure**. Mains Failure events in memory will be signalled by slow blinking.

Silence ON (glowing) indicates that the Alarm signalling devices have been silenced by means of the Silence button. To re-enable the devices, press the **Silence** button again. Silenced devices will be re-enabled automatically in the event of a new ALARM.

 **The Silence button can be used during Access Level 2 only.**

Ack./Evac. ON (glowing) indicates that the programmed Investigation time is running.

Reset ON (glowing) indicates that Reset cannot be carried out: press the **Silence** button.

 **The Silence button can be used during Access Level 2 only.**

Night Mode ON (glowing) indicates that the Control panel is operating in NIGHT Mode.

If the **Silence** button is pressed during NIGHT mode — SILENCE status will be held for the programmed **Night mode Silence time**.

OFF indicates that the Control panel is operating in DAY Mode. If the **Silence** button is pressed during DAY Mode — SILENCE status will be held until the **Silence** button is pressed again.

 **The Silence button can be used during Access Level 2 only.**

Disab./Fault NAC ON (glowing) indicates that the SUPERVISED/SILENCEABLE fire signalling devices have been DISABLED.

Fast blinking indicates that the SUPERVISED/SILENCEABLE fire signalling devices are unable to operate. Call your installer for service.

Disab./Fault Telecom ON (glowing) indicates that the Dialler has been DISABLED.

Fast blinking indicates that the DIALLER is unable to operate. Call your installer for service.

Zone Alarm ON (glowing) indicates that the zone concerned is in ALARM status. Verify the Alarm!

In the event of Fire, **ACTIVATE** an Evacuation Alarm by pressing and holding the **Ack./Evac.** key for **AT LEAST 5 seconds**.

In the event of False Alarm, press the **Reset** button to clear the Alarm status.

 **The Reset button can be used during Access Level 2 only.**

Disabled/Fault/Test ON (glowing) indicates that the zone concerned has been DISABLED by means of the respective button, therefore, it will be unable to trigger ALARMS.

Fast blinking indicates Fault status. Call your installer for service.

AE Silenceable Activated Extinguishment Output

This Output is for “Activated Extinguishment” signal.

Operating principles

- Standby status: negative pull-down to 0 V on the [+] terminal; positive pull-up to 27.6 V on the [-] terminal.
- Activated status: positive pull-up to 27.6 V on the [+] terminal; negative pull-down to 0 V on the [-] terminal.

☞ For correct operation of the output, the EOL resistor must be connected as shown in Figure 19 on page 33.

Up to 1 A can circulate on the AE Output.

☞ In the event of shorted or open connections on the AE Output, the output will not be activated.

PE Postpone Extinguishment. This output goes to negative when the **Inhibit Extinguishment** Input is activated. Up to 0.1 A can circulate on the PE Output.

The System Wiring

☞ Use shielded cable only for all connections, with one end of the shield connected to the Control panel negative terminal and the other left free.

⚠ **High Voltage leads (230 V) must be bunched separately from Low Voltage leads (24 V). All leads must be bunched in such a way as to avoid contact with other wiring and components.**

■ Connecting Fire Detectors

This Control panel supports Conventional Fire Detectors (i.e. devices which resemble the operating mode of open contacts during standby status, and resistors during Alarm status).

☞ **DO NOT connect more than 30 devices to each zone.**

Connect Conventional Fire Detectors as per Figure 14.

Operating principles

- Terminals **L1** and **L2**, respectively, the power input and output terminals of the detector (these terminals connect when the detector is attached to its base, and disconnect when it is removed);
- terminal **L** — the negative power terminal of the detector;
- EOL resistor **109** — to be connected between terminal **L1** and terminal **L** of the last detector. The EOL resistor allows the system to check continuity and detect short-circuits;
- Diodes **110** — necessary when the **Bypass Missing Detectors** option is enabled (further details in the following paragraph).

☞ Connect any unused zone terminals to negative with a 3900 ohm, 1/4 W resistor.

The Control panel and Expander Modules provide sufficient 3900 ohm, 1/4 W resistors to balance their zones.

This Control panel also accepts Fire detectors with Normally-Open Alarm Outputs, as shown in Figure 15. Connect a 680 ohm (**111**) resistor in series to the Normally-Open contact, then connect the series of the contact with the resistor and the Normally-Open contact to the zone terminal.

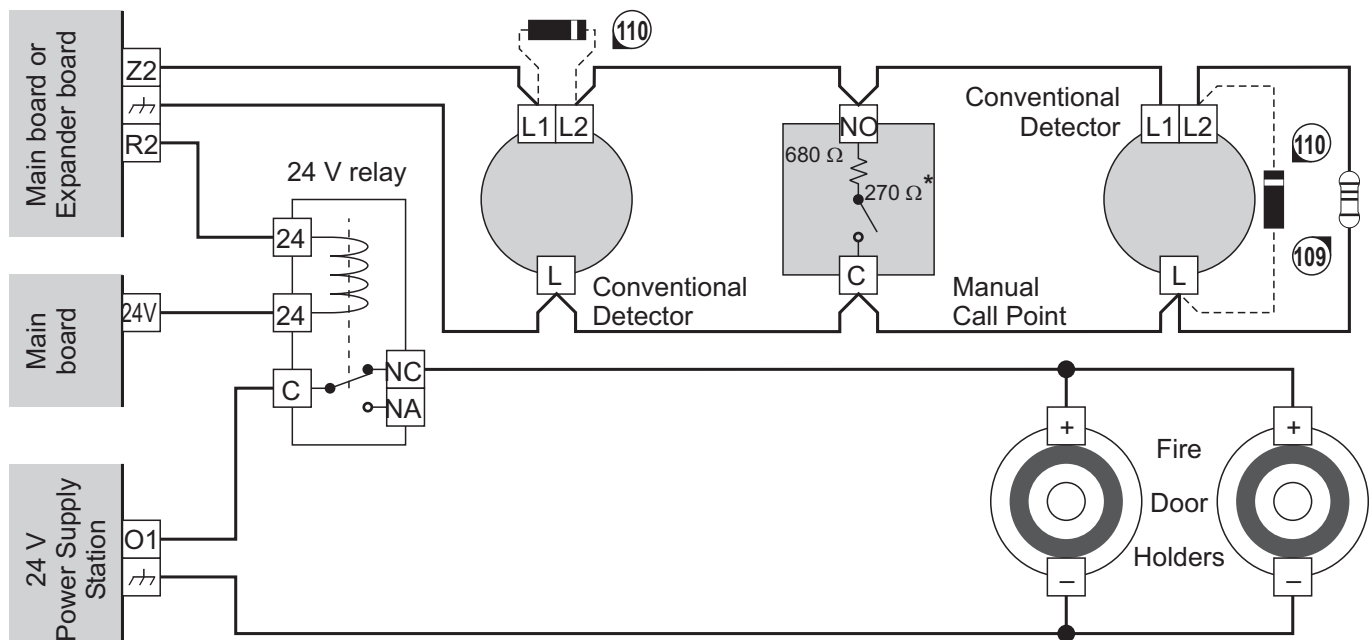

Figure 14 Wiring diagram of 3 detection devices to a zone: **109** 3900 ohm EOL Resistor, 1/4 W (orange-white-red-gold); **110** 1N5819 Diode (or similar) — necessary when the **Bypass Missing Detectors** option is enabled; *) Callpoint contact resistance — required if the **Call point priority**

Bypass Missing Detectors If this option is enabled, the zone concerned will exclude any inoperative (Missing) detectors from the system configuration, thus allowing detectors connected downstream of 'Missing' devices to operate as normal.

Wiring instructions for this feature:

— Connect **1N5819** diodes (or similar) to the power input and output terminals of all the detectors but the last, then connect a **1N5819** diode to the power output terminal and the negative terminal of the last detector (see part nr. **110** in Figure 14).

☞ *The polarity of the diodes must be observed (see Figure 14: the white band on part nr. **110** indicates the cathode).*

The Control panel monitors the system for "Missing" devices by inverting the polarity (every 60 seconds) of terminals belonging to zones with the **Bypass Missing Detectors** attribute (option ENABLED).

☞ *Polarity inversion DOES NOT damage the detectors as, during this status, only a 0.6 V negative voltage is present on the detector power terminals .*

■ Connecting Call-points

This Control panel accepts Normally Open Call-points with **680 ohm** contact resistance (wiring as per Figure 14), and Call-points with **zero ohm** contact resistance (wiring as per Figure 15).

Wiring instructions

Connect a **680 ohm (112)** resistor in series to the Normally-Open contact, then connect the series of the contact with the resistor and the Normally-Open contact to the zone terminal.

If the Call point is the last device or the zone, connect the EOL (**109**) to its NO and C terminals.

Call-point priority The zone concerned will discriminate between alarms triggered by Detectors and those triggered by Call-points. In the event of a Call-point alarm, the Control panel will generate an instant alarm regardless of the operating mode of the system (Day or Night Mode).

Wiring instructions for this feature:

Use Call-points with **270 ohm** contact resistance, or connect a **270 ohm** resistor in series to a Call-points with zero ohm contact resistance, as shown in Figure 15 (**111**).

■ Connecting Gas Detectors

This Control panel accepts Gas detectors with Normally Open Outputs (NO) and 4-20 mA gas detectors.

NO Output Connect Gas detectors with Normally Open Outputs (NO) as per Figure 16a.

Operating principles:

Terminal [A] (the Detector Alarm Output) will connect to terminal [-] when the concentration of gas in the area exceeds the preset safety threshold.

Wiring description:

Using a **680 ohm resistor (115)**, connect terminal [A] to the zone terminal.

Connect terminal [+] (the Detector Power input) to a power source that can be interrupted for the required reset time (see terminal [24R] on the Main Board).

Terminal [P] signals the pre-alarm status of the detector. If this state is to be detected, terminal [P] must be connected to the zone (refer to Figure 16a) using an **820 ohm resistor (116)** and the zone should be programmed with the attribute **Double N.O. Gas detector**, as described under "Zones" in the "PROGRAMMING FROM A PC" section.

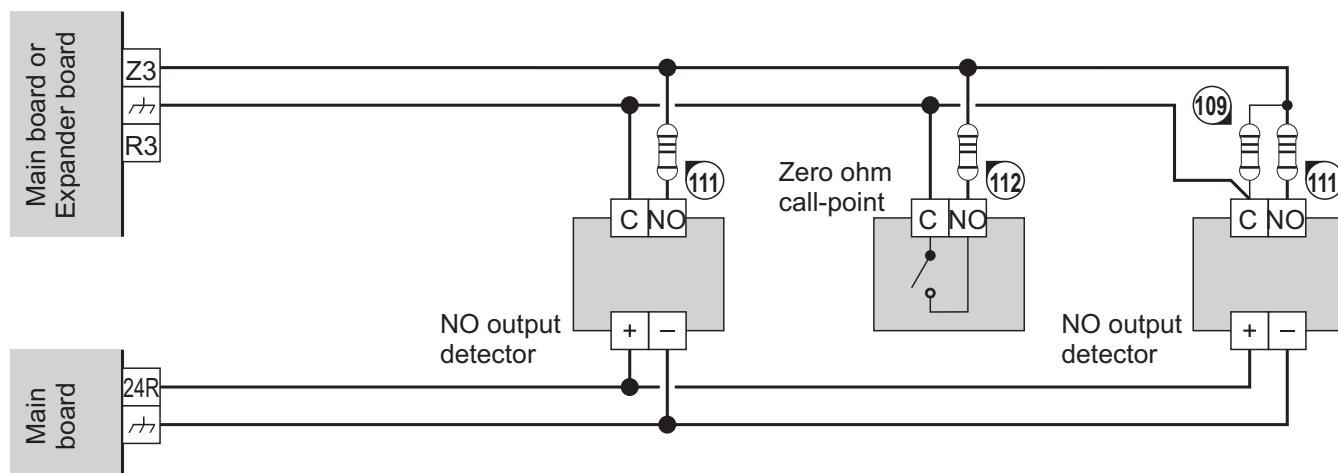

Figure 15 *Wiring diagram of 3 detectors with Normally-Open Outputs and a Call point with zero ohm contact resistance: **109** 3900 ohm, 1/4 W EOL resistor (orange-white-red-gold); **111** 680 ohm resistor; **112** 680 ohm resistor (necessary when **Call-point priority** option is DISABLED) or 270 ohm resistor when **Call-point Priority** option is ENABLED).*

☞ If terminal [P] is used, terminal [A] must also have an 820 ohm resistor.

The Repeat Output of the zone can be set up to interrupt the gas flow in the event of an alarm (wiring as per Figure 16a — see terminal [R4]).

If zone Z4 generates an alarm (or pre-alarm — when the **Pre-Alarm on R Output** option is ENABLED), terminal [R4] will pull down to 0 V (negative) thus activating the relay which in turn will latch the Switching Power supply to the Electrovalve.

☞ The current draw of Electrovalves must be provided by an external power source (e.g. BXM Power Station).

4 - 20 mA Gas detectors 4 - 20 mA Gas detectors can be connected to terminals [Z1] ONLY on the Main Board and Expander Module, as per Figure 16b.

Operating principles

The current draw of terminal [S] varies from 4 to 20 mA in accordance with the concentration of gas present in the area.

Wiring description

The [-] terminal is the negative power terminal.

Connect a 470 ohm, 2 W (**113**) between terminal [S] and terminal [-] of the detector.

Connect [+] terminal (positive power input) to a power source that can be interrupted for the required reset time (see terminal [24R] on the Main Board).

☞ Terminal [Z1] accepts ONE 4 - 20 mA Gas detector ONLY. If you are connecting a 4 - 20 mA Gas detector to terminal [Z1] of an Expander Module, remove the Jumper (**62**) (marked **GAS** on the PCB), and ENABLE the **Gas Detector** option of the respective zone (i.e. Zone nr. 1 for the Main Board, Zone nr. 9 for Expander Module nr. 1, zone nr. 17 for Expander Module nr. 2).

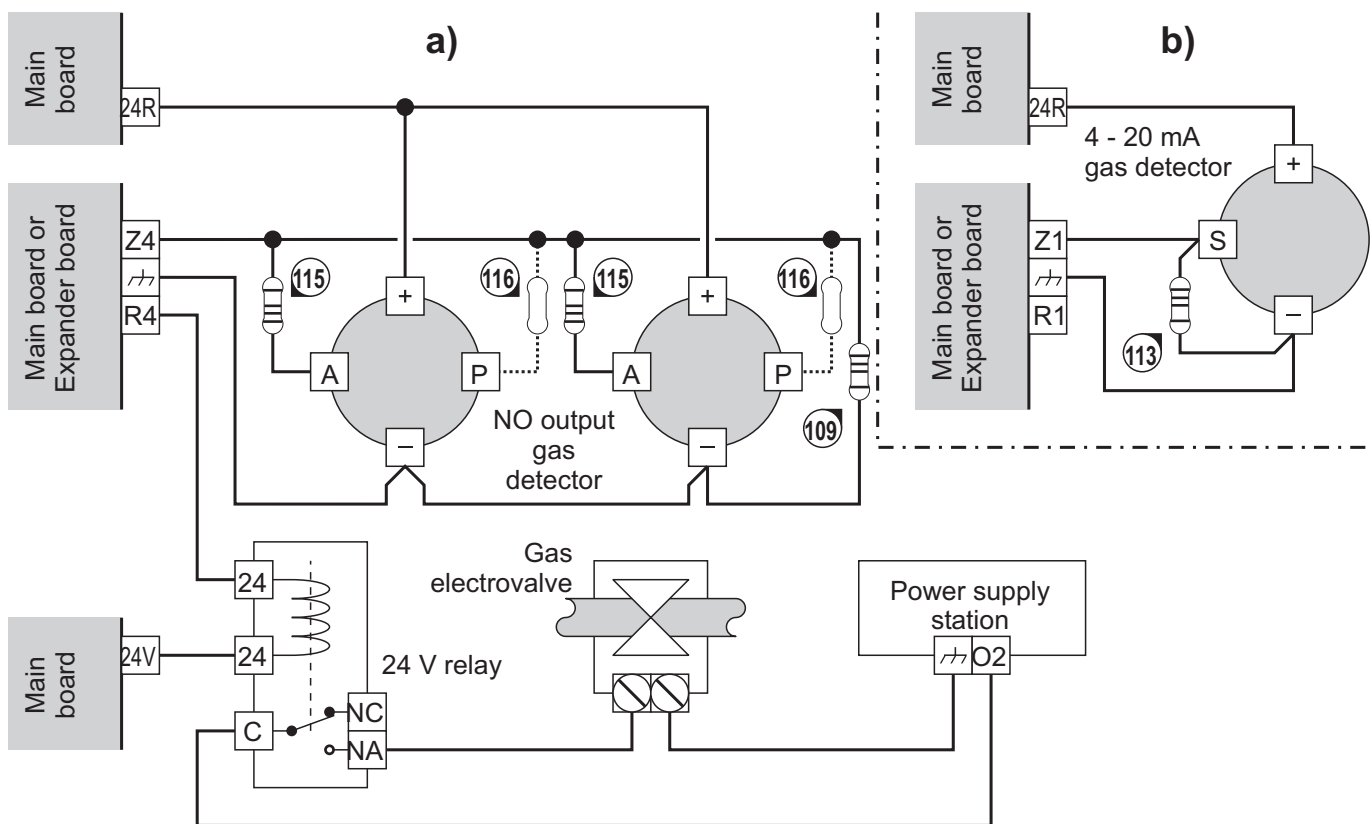

Figure 16 Wiring diagram of a Gas detector with Normally-Open Output (a) and a 4 - 20 mA Gas detector (b): **109**) 3900 ohm, 1/4 W EOL Resistor (orange-white-red-gold); **111**) 680 ohm resistor; **113**) 470 ohm resistor, 2 W; **115**) a 680 ohm resistor if the option **Double N.O. Gas detector** is disabled, or an 820 ohm resistor if the option is enabled; **116**) an 820 ohm resistor should be used only if the option **Double N.O. Gas detector** is enabled

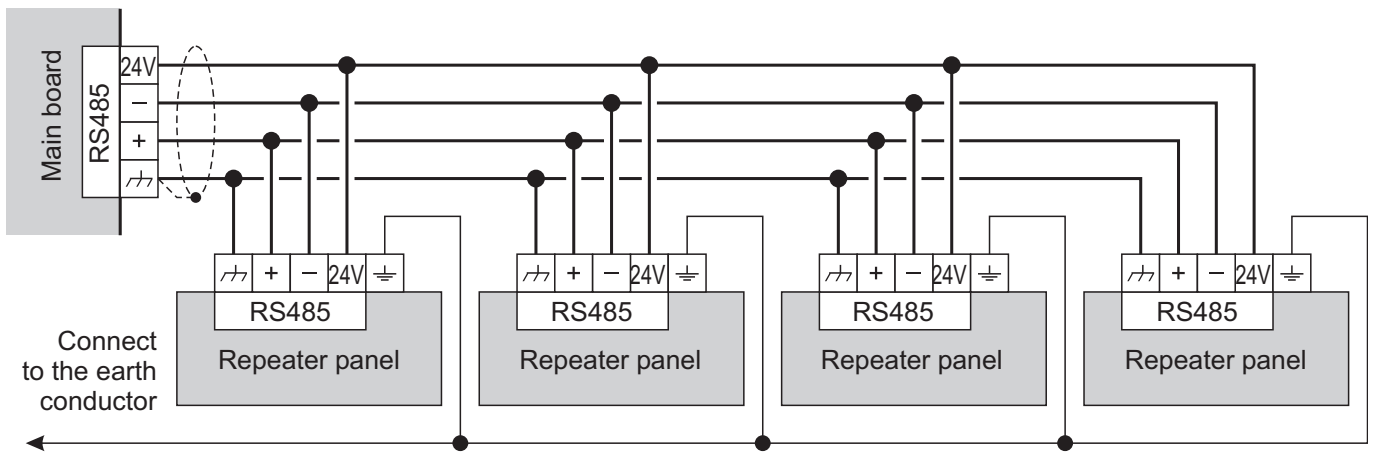

Figure 17 Wiring diagram of a Repeater connection

■ Connecting Signalling Devices

NAC1, NAC2 and ALARM outputs are for the alarm signalling device connections.

NAC1 and NAC2 can be set up to signal pre-alarm and alarm conditions (refer to “Outputs” under “PROGRAMMING FROM A PC”).

The wiring diagram in Figure 18 shows two warning lamps and the flasher of an outdoor signalling device (STROBE terminals) connected to NAC2, and two fire bells and the horn of an outdoor signalling device (HORN terminals) connected to NAC1. This type of connection makes it possible to diversify pre-alarm from alarm signalling.

For example, NAC2 will not activate during the pre-alarm phase, whereas, NAC1 will activate every 6 seconds for 2 seconds. NAC1 and NAC2 will always be active during alarm status.

➡ A **3900 ohm, 1/4 W resistor (109)** must be connected between the [+] and [-] terminals of the last device connected to NAC1 and NAC2. A **1N4007 diode (114)** (or similar) must be connected between the [+] terminals of devices connected to NAC1 and NAC2 and the [+] terminals of the latter.

■ Connecting a Repeater

Connect the **24V, -, +** and ⏏ terminals to the respective terminals on the Main Board of the Control panel, as shown in Figure 17.

➡ The maximum wire length connected the RS485 terminals of the Control panel must not exceed 1000 metres.

Connect the ⏏ terminal of the Repeater to the Main Earth wire.

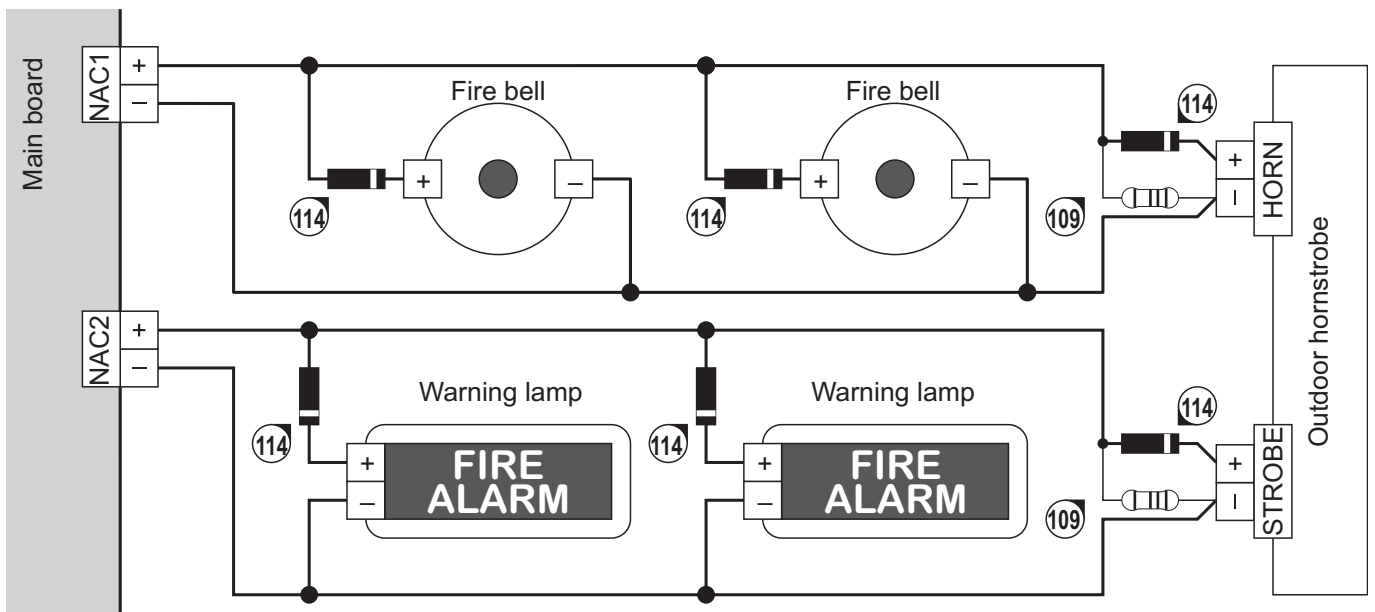
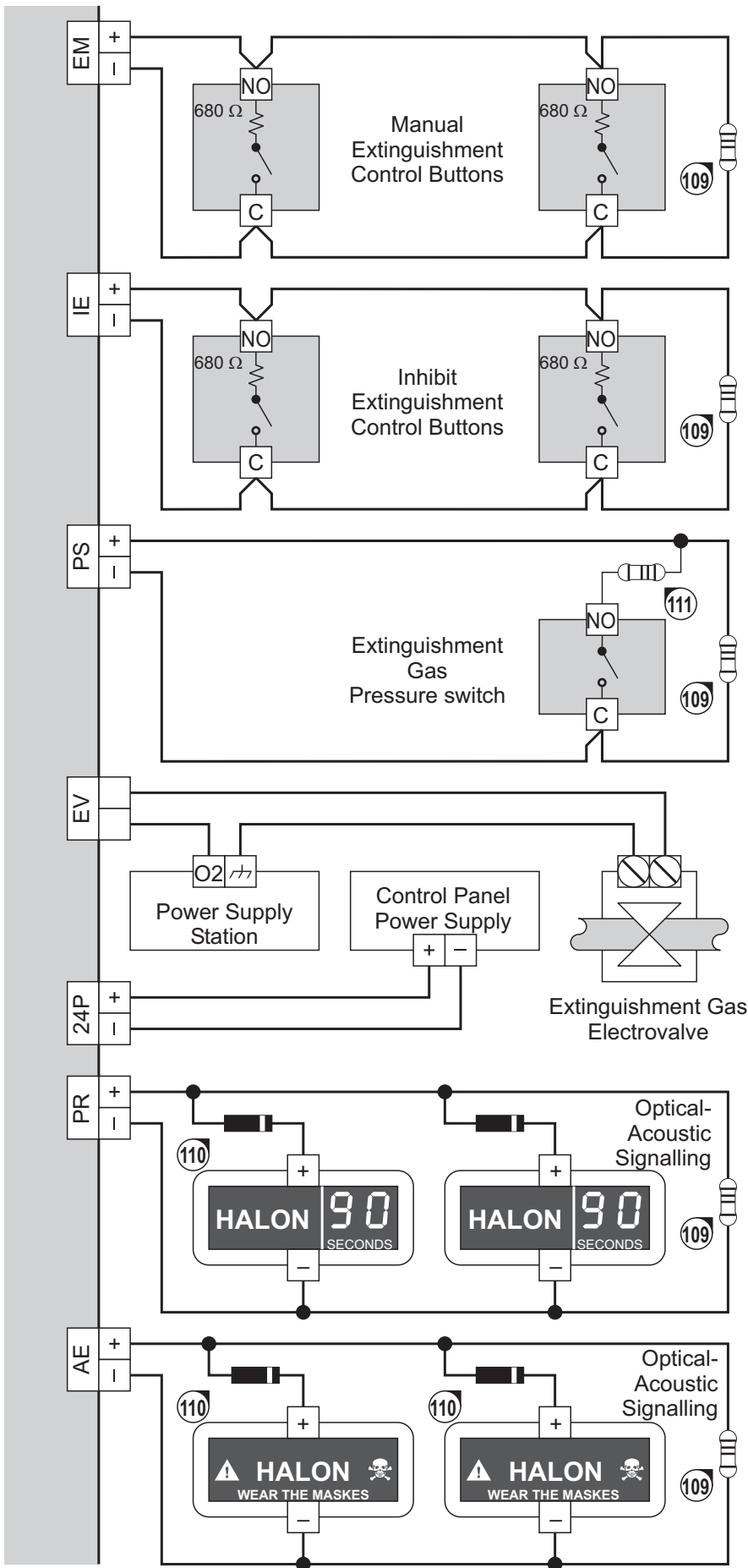

Figure 18 Wiring diagram of Signalling devices: **109** 3900 ohm, 1/4 W EOL Resistor (orange-white-red-gold); **114** 1N4007 Diode or similar



■ Connecting Extinguishment Modules

The wiring diagram in Figure 19 shows an Extinguishment Module connected to the Control panel. The EM inputs (Manual Extinguishment) and IE inputs (Inhibit Extinguishment) accept Normally-Open control buttons with 680 ohm contact resistance.

Wiring description:

Connect a 3900 ohm, 1/4 W resistor (109) between terminal [NO] and terminal [C] of the last control button.

The PS input accepts pressure switches with Normally-Open output and 680 ohm contact resistance.

Wiring description:

Connect a 680 ohm resistor (111) between one of the pressure switch terminals and the [+] terminal of the PS input.

Connect (as near as possible to the last pressure switch connected to the PS input) a 3900 ohm, 1/4 W resistor (109) in parallel to the [+] and [-] terminals of the PS input.

Extinguishment Modules are unable to supply the high current draw required by Electrovalves, therefore, installation of an external Power Station is required.

Wiring description:

The Extinguishment Module is unable to supply the current draw of the PR and AE Outputs, therefore, it will be necessary to connect the 24P input to the Switching Power Supply of the Control panel, or to an external Power station.

The PR output (Pre-Extinguishment) and AE output (Activated Extinguishment) accept signalling devices that operate at 24V.

Wiring description:

Connect (as near as possible to the last device connected to the output) a 3900 ohm, 1/4 W resistor (109) in parallel to the [+] and [-] terminals of the output.

Connect a 1N4007 diode or similar, between the positive inputs of the devices connected to the PR and AE, and the [+] terminals of the latter.

Figure 19 Wiring diagram of an Extinguishment Module: **109)** 3900 ohm, 1/4 W EOL Resistor (orange-white-red-gold); **110)** 1N4007 Diode or similar; **111)** 680 ohm (blue-grey-brown-gold)

Connecting a Dialler

An example of how to connect a Dialler is shown in Figure 21. It is assumed that the dialler is activated when terminal L1 goes to negative.

Connecting a Power Supply

 The power circuits of this Control panel comply with the EN54-4 standard.

 **In order to comply with the Safety regulations in force, the Mains must be equipped with a bipolar isolating device for protection against over voltage and short-circuit to Earth (e.g. automatic isolating switch).**

This Control panel is powered from the Mains (230V/50 Hz) through a Switching power supply, located inside the case. The **J408** Control panel provides housing for two 12 V, 7 Ah maximum batteries, whereas, the **J424** Control panel provides housing for two 12 V, 17 Ah maximum batteries for power during Mains failure. The non-volatile memory will hold the programmed data at all times.

In the event of Mains failure, the:

- GREEN Mains LED will turn OFF
- AMBER Mains LED will turn ON

The Control panel will monitor the batteries at all times, (refer to **Static Test** and **Dynamic Test**).

Static Test The **Static Test** monitors the battery charge during Mains failure. In the event of **Low battery** status (below 22.8 V), the **Battery LED** will turn ON. If this occurs, the Mains power must be restored before the batteries empty, otherwise, the system will shutdown. Low battery restoral (over 24.6 V) will be signalled by blinking on the **Battery LED** (Memory).

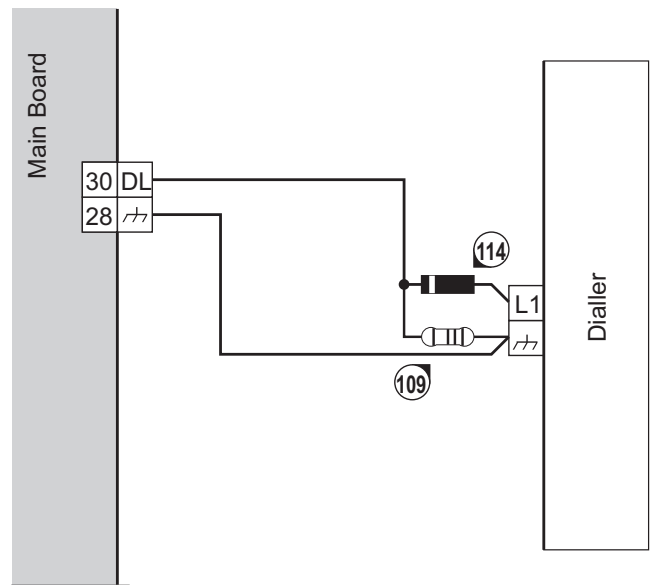

Figure 21 Connecting a Dialler: **109**) 3900 ohm, 1/4W (orange-white-red-gold) EOL resistor; **114**) 1N4007 diode, or equivalent.

Dynamic Test The **Dynamic Test** monitors the operating capacity of the batteries. In the event of a Failed Test result (batteries do not meet the Test requirements), The **Battery LED** will turn ON. If this occurs, the backup battery must be replaced immediately, otherwise, the system will be unable to function in the event of Mains failure (black-out). Battery trouble restoral will be signalled by blinking on the **Battery LED** (Memory).

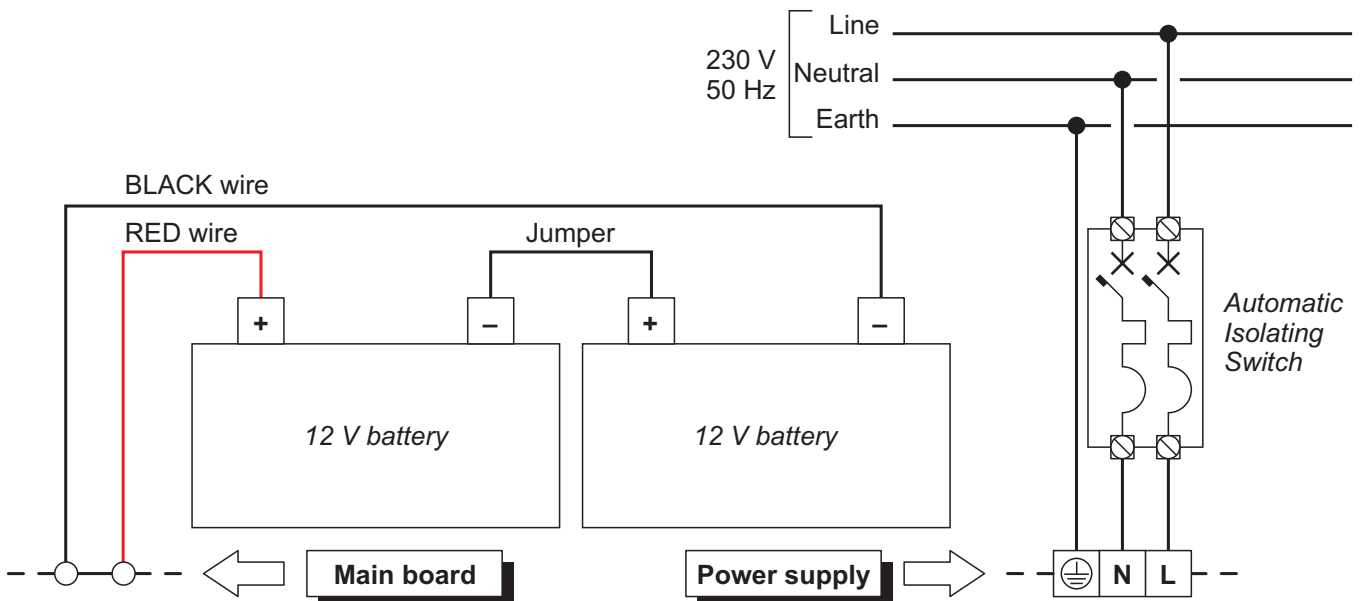

Figure 20 Wiring diagram for the power supply

■ Connecting the Mains Supply

Work carefully through the following steps (refer to the figures on pages 12, 14, 18 and 19).

1. Locate the backup batteries in the housing **20**.
2. Using the Jumper (supplied), connect the batteries in series.
3. Observing the battery polarity, connect the battery terminals to the wires **60**.

☞ *If you are connecting 17 Ah batteries, you must replace the wire **60** and jumper connectors.*

☞ **J424:** Use 17 Ah @ 12 V YUASA NP 17-12 FR batteries;
J408: Use 7Ah @ 12 V YUASA NP7-12 FR batteries; or similar with case flame class UL94-V2 (or higher).

4. Connect the **Earth** wire to the [⊕] terminal on the terminal board **53**.
5. Connect the **Neutral** wire to terminal [N], and the **Line** wire to terminal [L] on the terminal board **53**.

☞ *The Control panel will reset on power up.*

⚠ **DO NOT allow the power cable to cross over other wiring (see Figure 22a). The power cable must be routed as per Figure 22c and held firmly in place by a cable tie (see Figure 22b).**

■ Thermal Probe

This Control panel supports the **KST** thermal probe. The probe will optimize the battery charging process by regulating the charge voltage in accordance with the battery temperature.

Work carefully through the following instructions (refer to the figure on pages 12, 14, 18 and 19):

1. Connect the probe **24** to the connector **38** on the Main board of the Control panel.
2. Attach the probe to one of the batteries, in such a way as to obtain optimum heat transfer.
3. Measure the Probe temperature.
4. Using the graph in Figure 23 and/or Table 3, find the value (in accordance with the battery temperature) that the output voltage of the Switching Power Supply will be based on.
5. Using the trimmer **51**, adjust the voltage on the terminal board **52** to the required value.

☞ *NOTE: to verify the battery efficiency, the PCB will measure the internal resistance. In order for this measure is not distorted, you should use only the cables supplied; cables that are longer and have an insufficient section may erroneously simulate the condition of inefficient battery.*

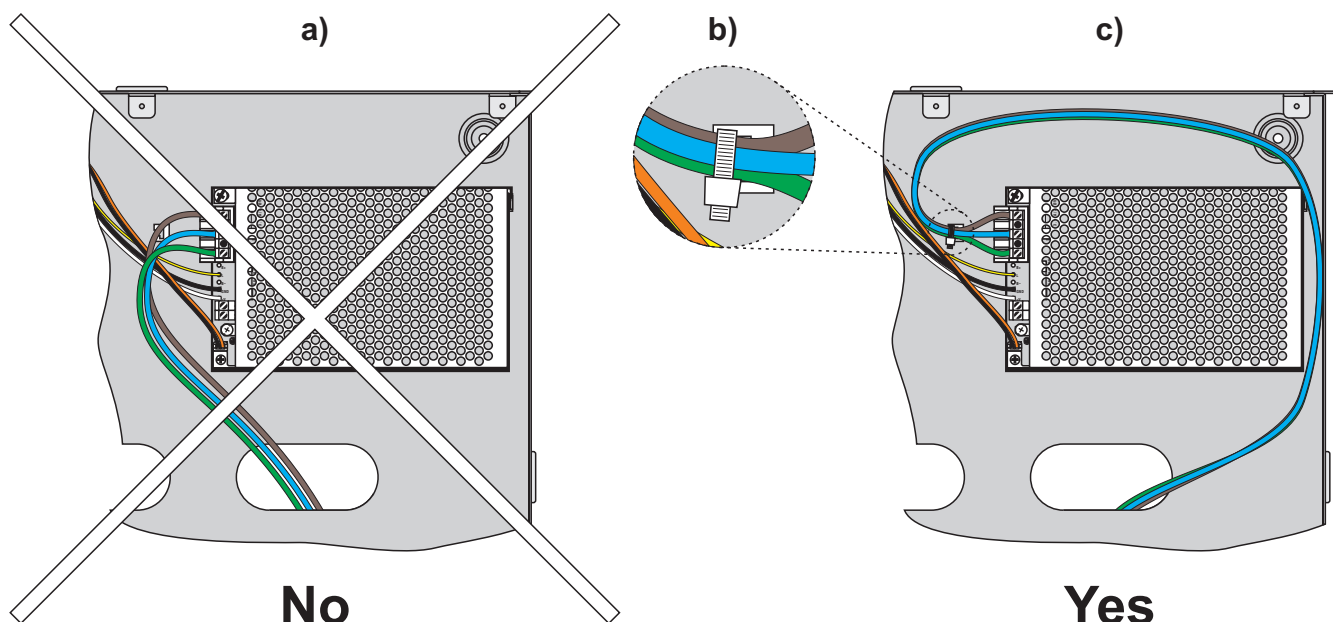

Figure 22

Maintenance

The following operations must be carried out regularly.

A Using a damp cloth (DO NOT USE SOLVENTS OF ANY KIND), remove dust from the Control panel case.

B Using the **Test** key, check that the LEDs and buzzer are functioning properly.

C Ensure that the batteries are sufficiently charged and functioning properly. If not, replace them immediately.

D Ensure that all cables and connections are intact.

E Ensure that there are no unrelated objects inside the Control panel case.

 Points **A** and **B** may be carried out by users. Points **C**, **D** and **E** must be carried out by qualified persons only.

Testing the Extinguishment Module

The Extinguishment Module may be tested as described below.

1. With the Control panel set to Access Level 1, activate the Extinguishment Module.
2. Check that the Extinguishment Module is working correctly.
3. Type in the **Extinguishment Termination Code** (refer to "Control panel" in the "PROGRAMMING FROM A PC" section) then press the **Disable Extinguish.** button to stop the Extinguishment Time.

 When the Extinguishment Termination Code has been entered, 5 beeps in rapid succession will be heard. The Extinguishment Termination Code may only be entered at Access Level 1. After 20 seconds, the Extinguishment Termination Code will no longer work (double beep).

4. Check that the EV Output has been deactivated.

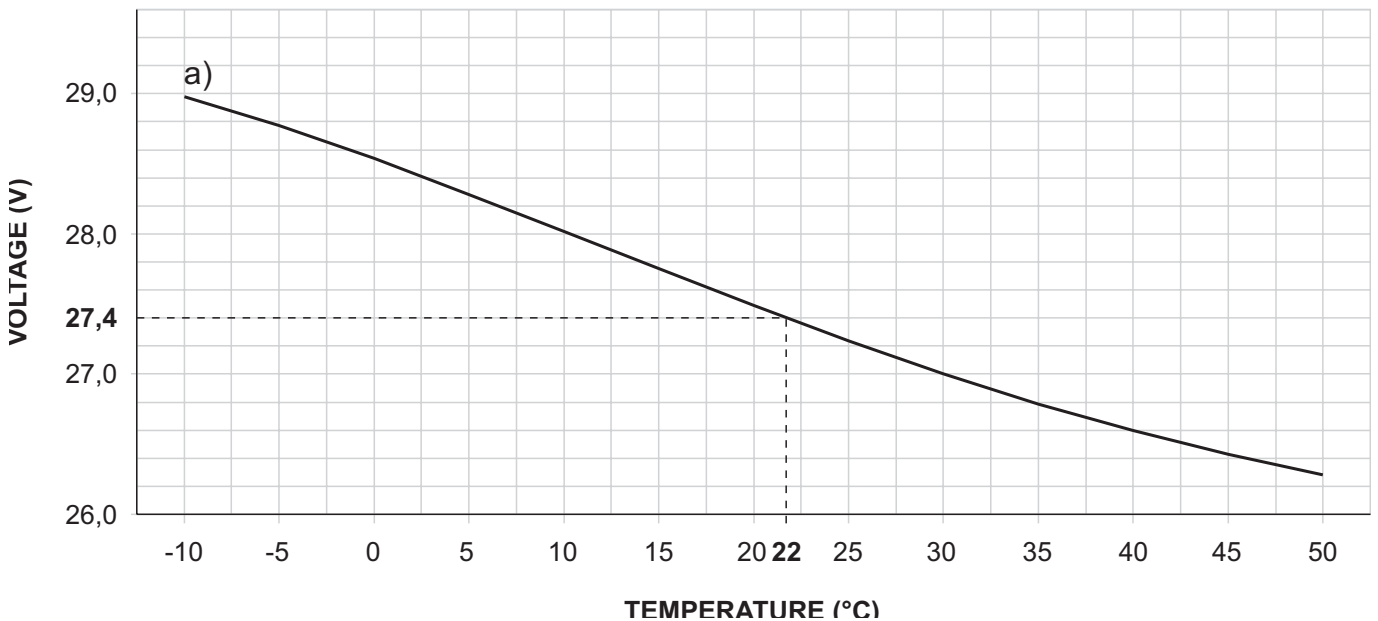

Figure 23 Switching Power Supply Output Voltage graph. To find the Output Voltage using the graph: — indicate the Probe temperature on the **TEMPERATURE (°C)** axis; draw a line from the temperature value point up to the curve **a)**; draw a line from the intersection point across to the **VOLTAGE (V)** axis; adjust the Output Voltage of the Switching Power Supply to the resultant value. For example, if the Probe temperature is 22 °C, the Output Voltage of the Switching Power Supply must be set at 27.4 V.

TEMPERATURE (°C)	-10	-5	0	5	10	15	20	25	30	35	40	45	50
VOLTAGE (V)	29.0	28.8	28.6	28.2	28.0	27.8	27.4	27.2	27.0	26.8	26.6	26.4	26.2

Table 3 Switching Power Supply Output Voltage chart. To find the Output Voltage using the chart: — select the nearest value to the Probe temperature on the **TEMPERATURE (°C)** row; read the respective value on the **VOLTAGE (V)** row; adjust the Output Voltage of the Switching Power Supply to the indicated value. For example, if the Probe temperature is 22 °C, the Output Voltage of the Switching Power Supply must be set at 27.4 V.

You can program this system from the Control panel or from a computer, using the **J400** application.

This section describes how to program the system from a computer. If you intend programming the system from the Control panel refer to the “PROGRAMMING FROM THE PANEL” section.

Enrolling: Expander Modules

The **Expander Modules** page will allow you to enrol Expander Modules, as follows.

- Enrol the Expander Modules (if installed).
A tick () indicates that the respective device is part of the system.

Description This 16 character field will allow you to assign a label to the Expander Module. For example, if the Expander Module monitors a particular part of the premises, it may be useful to assign the name of the area concerned. The assigned label will identify the Expander Module in all the operations it is involved in.

Enrolling: Extinguishment Modules

The **Extinguishment Modules** page will allow you to enrol and set up Extinguishment Modules, as follows.

- Enrol the Extinguishment Modules (if installed).
A tick () indicates that the respective device is part of the system.

Description This 16 character field will allow you to assign a label to the Extinguishment Module. For example, if the Extinguishment Module is intended for fire extinction in a particular part of the premises, it may be useful to assign the name of the area concerned. The assigned label will identify the Extinguishment Module in all the operations it is involved in.

Setting up an Extinguishment Module:

— select the Extinguishment Module on the left-hand side of the page, then program the respective parameters on the right-hand side of the page, as follows.

Figure 24 The *Extinguishment Modules* page

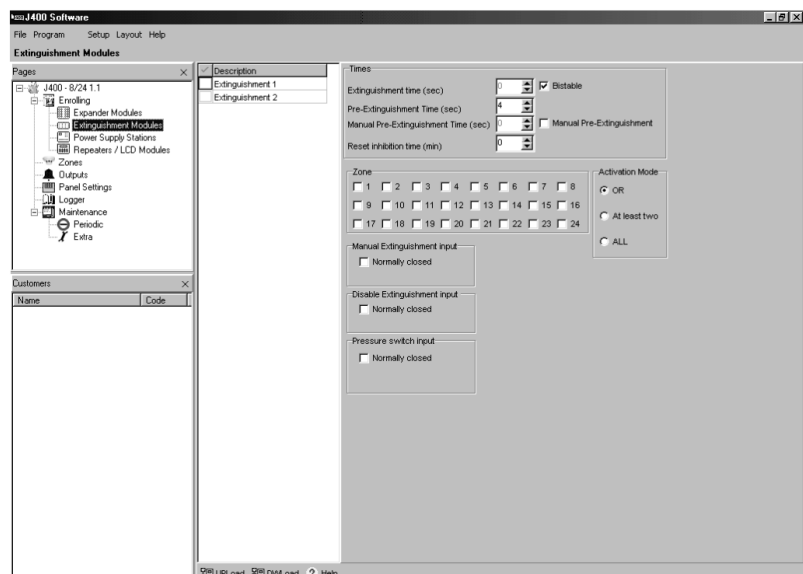

■ Activation Mode

This section will allow you to select the logic that will activate the Extinguishment phase, as follows.

 *When some zones are in alarm, a condition of pre-activation is signalled by the Control panel by means of the **ON Pre. Ext.**, which flashes quickly.*

OR If you ENABLE this option, at least ONE of the Zones — selected in the **Zones** chart — must detect alarm conditions.

At least TWO If you ENABLE this option, at least TWO of the Zones — selected in the **Zones** chart — must detect alarm conditions.

All If you ENABLE this option, ALL the Zones — selected in the **Zones** chart — must detect alarm conditions.

■ Times

This section will allow you to set the Extinguishment Times.

Pre-Extinguishment Time This field will allow you to program a delay between verification of the **Activation Mode** conditions and activation of the Electrovalve output ([EV] terminals). The Pre-Extinguishment output ([PR] terminals) will be active during the Pre-Extinguishment Time.

Accepted values: 0 to 60 seconds, in steps of 1 second.
Default value: 20 seconds.

Extinguishment Time This field will allow you to set the Extinguishment Time. If you DISABLE the **Bistable** option, the EV output will restore to standby when the programmed Extinguishment Time expires.

Accepted values: 0 to 300 seconds (5 minutes) in steps of 5 second.

Bistable If you ENABLE the **Bistable** option, the EV output will restore to standby when the Control panel Resets.

Manual Pre-Extinguishment Time Set the time that must elapse from the point at which the EM Input is activated to the point at which the Electrovalve Output ([EV] terminals) are activated. During the Manual Pre-Extinguishment Time, the Pre-Extinguishment Output ([PR] terminals) is activated.

Accepted values: 0 to 60 seconds, steps of 1 second.
Default value: 0 seconds.

Manual Pre-Extinguishment When the Manual Pre-Extinguishment option is enabled, the Manual Pre-Extinguishment Time may be set. When the option is disabled, the Pre-Extinguishment Time will also be used by the Control panel for manual activation.

Reset Inhibit Time This is the amount of time that must elapse from the point at which the Extinguishment Module is enabled to the point at which the module may be reset. If the reset is performed during the Reset Inhibit Time, the Control panel will reset all systems (except for the activated Extinguishment Module) for a few seconds, after which it will return to an alarm condition. Accepted values: 0 to 30 minutes, steps of 1 minute. Default value: 0 minutes.

■ Zones

This section will allow you to select the Zones which will activate the Extinguishment phase.

■ Manual Extinguishment Input

This field will allow you to set up the Standby status of the Manual Extinguishment Input ([EM] terminals).

Normally Closed If this option is DISABLED (at Default), there must be a 3900 ohm resistance across the [+] and [-] terminals of the EM Input during Standby status. When this option is enabled, the resistor in standby must be 680 ohm.

■ Disable Extinguishment Input

This field will allow you to set up the Standby status of the Disable Extinguishment Input ([IE] terminals).

Normally Closed If this option is DISABLED (at Default), there must be a 3900 ohm resistance across the [+] and [-] terminals of the IE input during Standby status. When this option is enabled, the resistor in standby must be 680 ohm.

■ Pressure Switch Input

This field will allow you to set up the Standby status of the Pressure Switch Input ([PS] terminals).

Normally Closed If this option is DISABLED (at Default), there must be a 3900 ohm resistance across the [+] and [-] terminals of the PS input during Standby status. When this option is enabled, the resistor in standby must be 680 ohm.

Enrolling: Power Supply Stations

The **Power Supply Stations** page will allow you to enrol and set up Power Supply Stations, as follows.

Enrol the Power Supply Stations (if installed).
A tick () indicates that the respective Power Supply Station is part of the system.

Description This 16 character field will allow you to assign a label to the respective Power Supply Station. For example, it may be useful to assign the name of the area where the device is located. The assigned label will identify the Power Supply Station in all the operations it is involved in.

Enrolling: Repeaters and LCD Modules

The **Repeaters and LCD Modules** page will allow you to enrol Repeater panels and LCD Modules, as follows.

Enrol the Repeater panels and Display Modules (if installed).

A tick () indicates that the respective device is part of the system.

Description This 16 character field will allow you to assign a label to the respective device. For example, it may be useful to assign the name of the area where the device is located. The assigned label will identify the device in all the operations it is involved in.

Zones

The **Zones** page will allow you to program the Zones

The chart on the left-hand side of the page shows the number of zones available on the system, depending on whether or not the system utilizes Expander Modules (refer to “Enrolling: Expander Modules”). The following information is shown for each Zone.

No. This field shows the ID Number of the Zone.

Position This field shows the Description of the device the Zone is assigned to.

Description This field will allow you to assign a label to the Zone. The assigned label will identify the Zone in all the operations it is involved in.

The section on the right-hand side of the **Zones** page will allow you to program and/or change the settings of the selected Zone (selected from Zones chart), as follows

■ Thresholds

This Control panel can detect whether its Zones are Shorted, Open or in Alarm status by measuring the voltage on the respective Zone terminals.

The Thresholds are the voltage values that cause the Zones to switch from one status to another, as follows.

Open/Standby The Control panel will consider the Zone in OPEN status when the voltage on its terminals exceeds the value programmed in this field.

The Control panel will consider the Zone in STANDBY status when the voltage on its terminals ranges between value programmed in this field and the value programmed in the **Standby/Auto.Alarm** field.

Standby/Auto.Alarm If the **Call point Priority** option has been ENABLED, the Control panel will consider the Zone ALARM status when the voltage on its terminals ranges between the value programmed in this field and the value programmed in the **Auto.Alarm/Manual Alarm** field. If the **Call point Priority** option has been DISABLED, the Control panel will consider the Zone ALARM status when the voltage on its terminals ranges between the value programmed in this field and the value programmed in the **Manual Alarm/Short** field.

Auto.Alarm/Manual Alarm If the **Call point Priority** option has been ENABLED, the Control panel will consider the Zone in MANUAL ALARM status when the voltage on its terminals ranges between the value programmed in this field and the value programmed in the **Manual Alarm/Short** field.

Manual Alarm/Short The Control panel will consider the Zone in MANUAL ALARM status when the voltage on its terminals is below the value programmed in this field.

Changing the Default Thresholds:

— select the “**key**” button, then enter the new values (in accordance with the number and features of the zone connected devices).

Figure 25 The Zones page

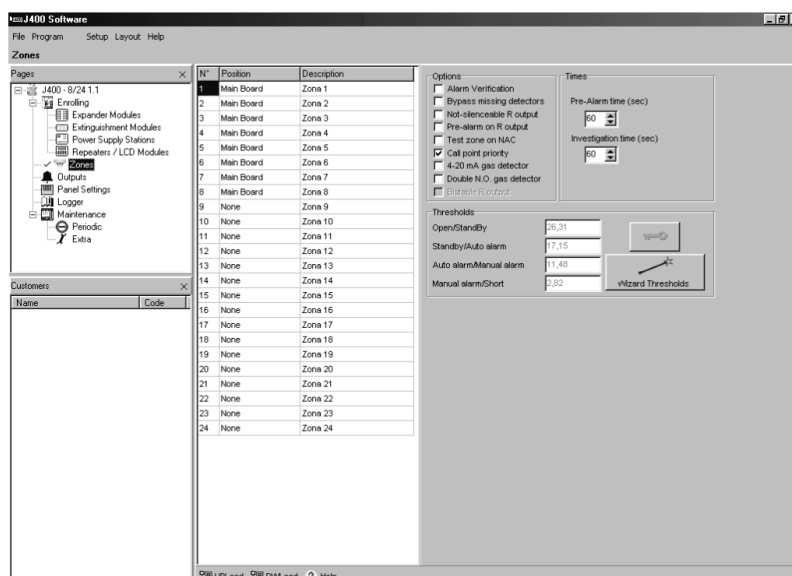

For step by step instructions on how to set up the Thresholds:

— select the “**Wizard Thresholds**” button.

 The “**Wizard Thresholds**” option can be used only when the Control panel connected to a computer, and is in “Programming” status (as described in the “Downloading” paragraph).

■ Options

This section will allow you to assign the Zone “attributes”.

Alarm Verification If this option is ENABLED, Alarm will be verified as follows:

- the system will not generate a Control panel Alarm when the Zone first detects Alarm conditions;
- the system will reset the Zone and start the **Alarm Verification Time** (refer to “Panel settings”);
- if the Zone triggers another Alarm while the Alarm Verification Time is running, the system will generate a Control panel Alarm.

Bypass missing detectors If the Zone is wired to bypass missing detectors, this option **MUST BE ENABLED**.

NON-Silenceable R Output If this option is ENABLED, the Repeat Output of the Zone concerned ([Rn] terminal) CANNOT be Silenced.

Pre-Alarm on R Output If this option is ENABLED, the Control panel will activate the Repeat Output of the Zone concerned ([Rn] terminal) during the Pre-Alarm phase.

Test zone on NACs If this option is ENABLED, the Control panel will activate the NAC1 and NAC2 Outputs for 1 second when the Zone is undergoes testing.

Gas Detector If this option is ENABLED, it will be possible to connect a 4 - 20 mA Gas Detector to the Zone terminal.

 The **Gas Detector** option can be ENABLED ONLY for Zones 1, 9 and 17, respectively, the [Z1] terminals on the Main Board, and on Expander nr. 1 and Expander nr. 2.

Double N.O. Gas Detector This option should be enabled when using terminal [P] of the detector. When this option is ENABLED, Zone thresholds will be automatically adjusted to the connection illustrated in Figure 16a on page 31. Thus, the Control panel will be able to detect 2 activation thresholds, one for the Pre-Alarm and one for the Alarm.

R Output Bistable This option is only available when the **Double N.O. Gas detector** is enabled.

In this case, when the option **R Output Bistable** is enabled, the R Output of the zone is activated when the zone exceeds the alarm threshold (or the pre-alarm threshold, if the option “Pre-Alarm on R Output” is enabled) and returns to standby when the zone falls below the alarm threshold, irrespectively of the Control panel status.

If the option **R Output Bistable** is disabled (factory de-

fault), the R Output returns to standby when the Control panel is reset.

■ Times

Pre-Alarm Time This field will allow you to program the delay between the Zone Alarm and the Control panel Alarm.

 If several Zones trigger Alarms within seconds of one another, the Control panel will generate an Alarm when the shortest Pre-Alarm Time of all the Zones concerned expires.

Accepted values: 0 to 300 seconds (5 minutes), in steps of 10 seconds.

Default setting: 60 seconds.

Investigation Time This field will allow you to program an “interval” that will override the Pre-Alarm Time. This “interval” will allow users time to investigate fire alerts. It will be applied when the **Ack/Evac.** key is pressed for less than 5 seconds at Access Level 2 (Keyswitch ENABLED or PIN Code entered).

Accepted values: 0 to 300 seconds (5 minutes), in steps of 10 seconds

Default value: 60 seconds.

Outputs

The **Outputs** page controls the pulse pattern for Pre-Alarm (Alert) and/or Alarm (Evacuate) signalling on the NAC1 and NAC2 outputs, and Alarm (Evacuate) signalling on the ALARM output.

The pattern is represented by a series of bells, each bell representing a second.

The configuration of the RED and WHITE backgrounds (for On and Off respectively e.g. all RED indicates continuously On) determines the respective pulse pattern.

For example, the output devices (connected to NAC1 and NAC2) can be configured to have one audible output for Pre-Alarm (Alert) and a different audible output for Alarm (Evacuate), thus allowing users to distinguish between the two conditions, as follows.

■ NAC1 Output

Pre-Alarm pattern The bell chart will allow you to program the Pre-Alarm (Alert) pattern of NAC1.

➤  = Output OFF for 1 second;

➤  = Output ON for 1 second.

Pre-Alarm Default setting: NAC1 will turn ON for 2 seconds then turn OFF for 6 seconds.

Alarm pattern To be set up in the same way as the Pre-Alarm pattern of NAC1 but for the Alarm pattern. Default setting: NAC1 is continuous.

■ NAC2 Output

Pre-Alarm pattern To be set up in the same way as the Pre-Alarm pattern of NAC1 but for the Pre-Alarm pattern of NAC2.

Pre-Alarm Default setting: NAC2 WILL NOT ACTIVATE during the Pre-Alarm Time.

Alarm pattern To be set up in the same way as the Alarm pattern of NAC1 but for the Alarm pattern of NAC2. Default setting: NAC2 is continuous.

Bistable If this option is enabled, the NAC2 Output returns to standby when all zones have returned to standby, irrespectively of the Control panels' status. If this option is disabled (factory default), the NAC2 Output returns to standby when the Control panel is reset.

*If the **Bistable** option is enabled, this will void compliance with Standard EN54-2 of the NAC2 Output.*

■ ALARM Output

Alarm Pattern To be set up in the same way as NAC1 but for the Alarm pattern of the ALARM Output. Default setting: the Alarm Output is continuous.

NON-Silenceable If this option is ENABLED, the ALARM Output cannot be SILENCED.

■ OC Output Events

This section will allow you to assign one or more of the following events to the OC Output ([OC] terminal), as follows.

Alarm If you assign this event, the OC Output will activate when the Control panel generates an Alarm, and will restore to standby when the Control panel Resets.

Pre-Alarm If you assign this event, the OC Output will activate when the Control panel generates Pre-Alarm, and will restore to standby when the Control panel generates an Alarm.

Fault If you assign this event, the OC Output will activate when the system detects trouble, and will restore when the trouble clears.

Reset If you assign this event, the OC Output will activate when the system generates Reset, and will remain active until Reset is completed.

Disable If you assign this event, the OC Output will activate when Zones are Disabled, and will restore when the Zones are Re-Enabled.

Test If you assign this event, the OC Output will activate when Zones are in Test status, and will restore when Test status ends.

Double Knock If you assign this event, the OC Output will activate when TWO or more Zones generate Alarm, and will restore to standby when the Control panel Resets.

If you assign more than one event, the OC Output will activate when one of the assigned events occurs, and will Reset when ALL the assigned events end.

■ DL Output

The Dialler Output ([DL] terminal) will activate when its programmed delay expires. The delay countdown will start when the Control panel generates Alarm status.

*If the Alarm is triggered from a Call point (connected to a Zone with the **Call point priority** option ENABLED), the DL Output will activate instantly.*

Alarm Signalling Delay This field will allow you to program the Dialler Output delay. Accepted values: 0 through 600 seconds (10 minutes), in steps of 10 seconds; Default setting: 60 seconds.

*The **Alarm Signalling Delay** will be suspended during the **Silence** phase.*

Figure 26 The Outputs page

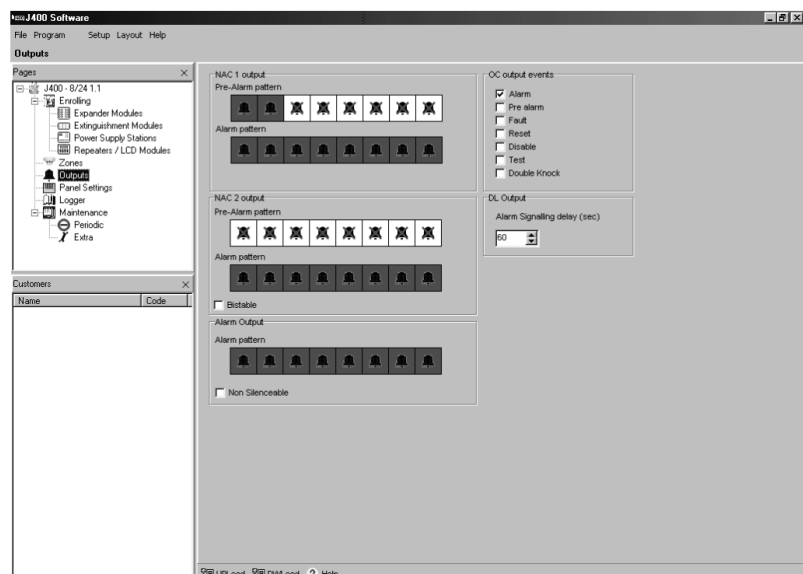

Panel Settings

The **Panel Settings** page will allow you to program the following parameters.

■ Day/Night

Automatic Night to Day Mode If this option is ENABLED, the changeover from Night Mode to Day Mode will occur automatically at the set Time (refer to “Night to Day Mode” in this section).

Automatic Day to Night Mode If this option is ENABLED, the changeover from Day Mode to Night Mode will occur automatically at the set Time (refer to “Day to Night Mode” in this section).

Night to Day Mode This field will allow you to program when the Control panel must change from Night to Day Mode.

This setting requires two digits for the Hour value and two for the Minutes value.

Use 00 to 23 (00 = Midnight) to set the Hour value.

Use 00 to 59 to set the Minutes value.

Day to Night Mode This field will allow you to program when the Control panel must change from Day to Night Mode.

This setting requires two digits for the Hour value and two for the Minutes value.

Use 00 to 23 (00 = Midnight) to set the Hour value.

Use 00 to 59 to set the Minutes value.

■ Reset

The Control panel Reset operation is divided into two phases: Reset and Stabilization.

During the Reset phase, the Control panel will interrupt the power supply to the devices connected to the Zones and the [24R] terminal.

During the Stabilization phase, the Control panel will ignore the status of the Zones.

This process is necessary, as some devices signal trouble conditions for several seconds after power-up.

The **Reset** section will allow you to program the Detector Reset and Stabilization Times.

Detector Reset Time This field will allow you to program the length of the power interruption that will reset the Detectors.

Accepted values: 0 through 15 seconds, in steps of 1 second.

Default setting: 8 seconds.

Detector Stabilization Time This field will allow you to program the length of time (necessary after Reset) that the system will ignore the Zone Status.

Accepted values: 0 through 5 seconds, in steps of 1 second.

Default setting: 2 seconds.

■ User Code

The 4-digit User Code will allow access to Level 2 of the Control panel.

Default setting: 1234

■ Alarm Verification Time

This field will allow you to program the Alarm verification window, that is, the time within which a Zone (with the **Alarm Verification** option ENABLED) must trigger two Alarm events in order for the system generate a Control panel Alarm.

Accepted values: 10 through 600 seconds (10 minutes), in steps of 5 seconds

Default setting: 60 seconds

■ Extinguishment Termination Code

The Extinguishment Termination Code is a 4-digit number that allows the Extinguishment Time to be stopped for test purposes (refer to “Testing The Extinguishment Module” in the “INSTALLING THE CONTROL PANEL” section).

Figure 27 The *Panel Setting* page

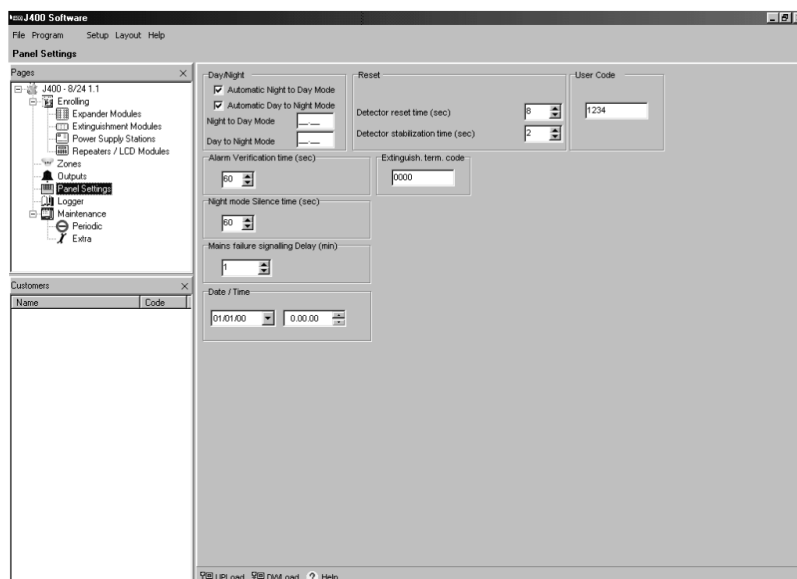

Type in the **Extinguishment Termination Code** than press the **Disable Extinguish.** button to stop the Extinguishment Time.

 *When the Extinguishment Termination Code is entered, this will be acknowledged by 5 beeps in rapid succession. The Extinguishment Termination Code may only be entered at Access Level 1. After 20 seconds, the Extinguishment Termination Code will no longer have any effect (double beep).*

■ Night Mode Silence Time

This parameter determines how long the Control panel will hold "Silence" status during Night Mode.
Accepted values: 0 through 600 seconds (10 minutes), in steps of 5 seconds
Default setting: 60 seconds

■ Mains Failure Signalling Delay

This parameter determines how long the Control panel will wait before signalling a Mains Failure event.
Accepted Values: 0 through 30 minutes, in steps of 1 minute.
Default Setting: 0 minutes.

■ Date/Time

This field is for the current date and time.

Downloading

Once the operating parameters have been set up, they must be downloaded to the respective Control Panel, as follows.

1. Remove the screws **4** and open the Control panel.
2. Connect the jumper **65** to the **first and second terminal** pins on the 3-pin terminal strip marked **PRG** on the Main Board. All the Control panel LEDs will go OFF except for the **Disab./Fault Telecom** LED which will blink — to indicate that the system is ready for programming via computer.
3. Connect the Control Panel serial port (**67**) to one of the PC serial ports, as follows:
 - using a **CVSER/9F9F** link (accessory item), or a cable similar to the one in Figure 28a; connect the Control Panel to the PC;
 - if the PC serial port has 25 pins, use an **ADSER/9M25F** adapter (accessory item), or a cable similar to the one in Figure 28b.
4. Select the PC serial port used for connection with the Control panel, as follows:
 - select **Serial Ports** from the **Setup** menu;
 - select the serial port (**Control Panel** section);
 - click or **OK**.
5. Select the parameters to be downloaded, as follows:
 - select **Control panel** from the **Setup** menu;
 - select the Control panel type from the **Panel** menu;
 - select the respective firmware release from the **Firmware** menu;
 - click **OK**.

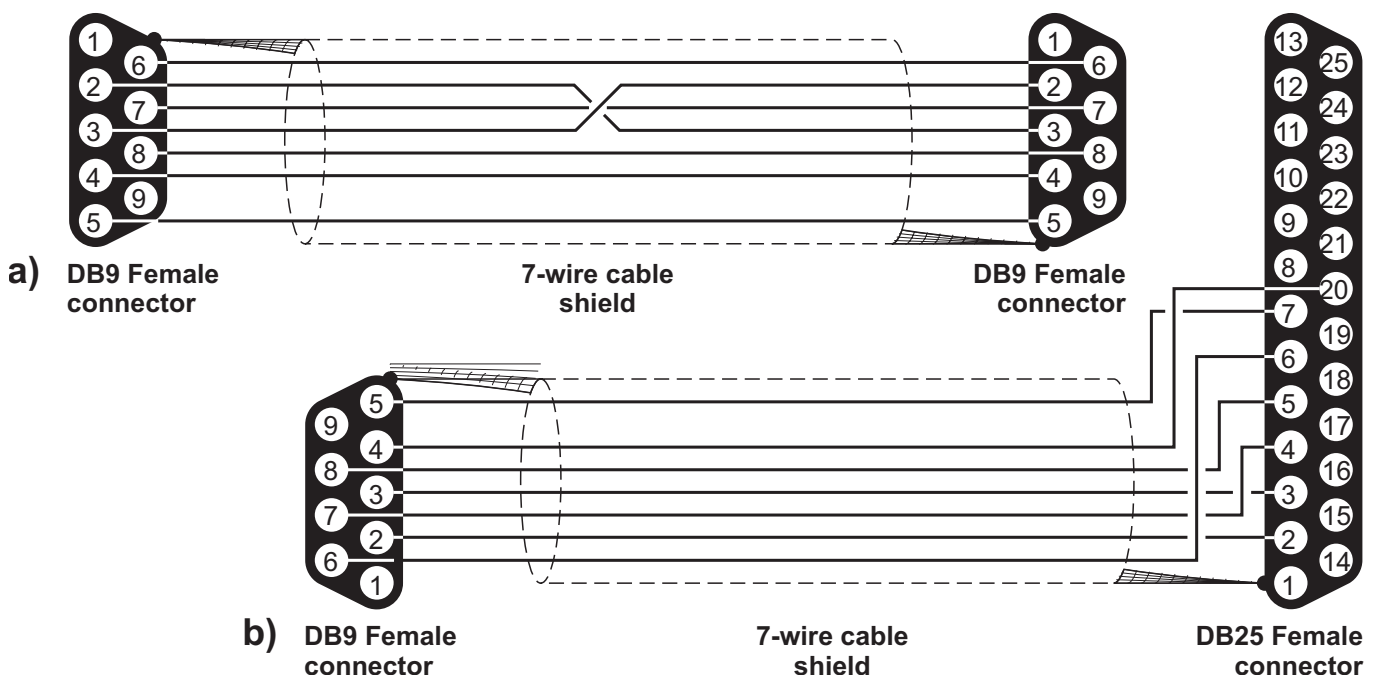

Figure 28 Wiring diagram for the serial link between the Control panel and PC

6. **To download a specific page:** click the **DWLoad** button on the page in question.

To Download several pages:

- select the required page from the **Pages** menu, right click, **Select** (a ✓ on the page Icon indicates that it will be downloaded);
- repeat the procedure for all the required Pages;
- right click again then select **DWLoad**.

 *To download a group of pages, select the root.*

For example: to download all the Configuration related pages, select **Configuration** from the **Pages** menu; to download **All** the Pages, select **J400** from the **Pages** menu.

7. *To view the Control panel parameters* — work carefully through point **6** then select **UPLoad** instead of **DWLoad**.

8. *To exit the Programming session* — connect the jumper **65** to the **second and third terminals** on the 3-pin terminal strip marked **PRG** on the Main Board. The Control panel will Reset automatically.

■ **Restoring Factory Defaults**

In order to restore factory defaults, press the **Reset** button for 5 seconds when the Control panel is in Programming status. A series of beeps will signal that the Control panel has restored the factory defaults.

PROGRAMMING FROM THE PANEL

Read through the following section carefully, in order to get an overall view of how to use the Programming Overlay during the various “Programming Phases”. For details regarding the parameters of each phase, refer to the respective paragraph in the “PROGRAMMING FROM A PC” chapter.

Using the Programming Overlay

The Programming Overlay is set up in columns. The LEDs in column **A** represent the Programming Phases: ① ZONES; ② TIMES; ③ OUTPUTS; ④ PANEL; ⑤ VARIOUS and ⑥ MODULES. Columns **B, C, D, E** and **F** are divided into panes, each pane providing a series of options. Each option is preceded by a number, representing the Programming Phase it belongs to (e.g. ② Pre-alarm time — column **C** belongs to the ② TIMES Programming Phase). The panes in column **B** have LEDs, those in columns **C** (except for the “Next Phase” key), **D, E** and **F** have LEDs and keys. During the programming session, the LEDs and keys will take on “Multi-Task” status, that is, they will operate in accordance with the Programming Phase concerned.

*Some options must be ENABLED/DISABLED by means of the Zone keys (Z1 through Z8 for the J408; Z1 through Z 24 for the J424). The Programming Overlay covers the keys of Zones 1 through 8 (Z1 . . . Z 8), however, there is no need to remove it, as these keys are clearly indicated in columns **E** and **F**.*

Accessing the Programming session

1. Remove the screws 4 and open the Control panel.

2. Connect the jumper 65 to the **first and second terminal** pins on the 3-pin terminal strip marked **PRG** on the Main Board. All the Control panel LEDs will go OFF except for the **Disab./Fault Telecom** LED which will blink — to indicate that the system is ready for programming via computer.
3. Press and hold the **Disab./Fault Telecom** key for at least 2 seconds. The green **Mains** LED will blink and the Amber **Mains** LED will go ON to indicate that the system is ready for programming via the Control panel.
4. Remove the cut-outs (for the LEDs), and insert the tabs of the Programming Overlay into the Zone label slots, as shown in Figure 29.
5. Press the **Next Phase** key 9 then select the group of parameters that you want to program: ZONES, TIMES; OUTPUTS; PANEL or VARIOUS (refer to the respective paragraph for details) *or*, if you want to program the Extinguishment Modules, press and hold (for at least 2 seconds) key 3 or key 6, respectively, Extinguishment Module nr. 1 and Extinguishment Module nr. 2 (refer to “Programming Modules” for details). The respective LED in column **A** will turn On to indicate the group of parameters concerned.

Exiting the Programming Session

Once programming has been completed, press key 9, then connect the jumper 65 to the **second and third terminals** on the 3-pin terminal strip marked **PRG** on the Main Board. The Control panel will Reset automatically.

*Press the **Next Phase** key 9 before repositioning the jumper, otherwise, the settings will not be saved.*

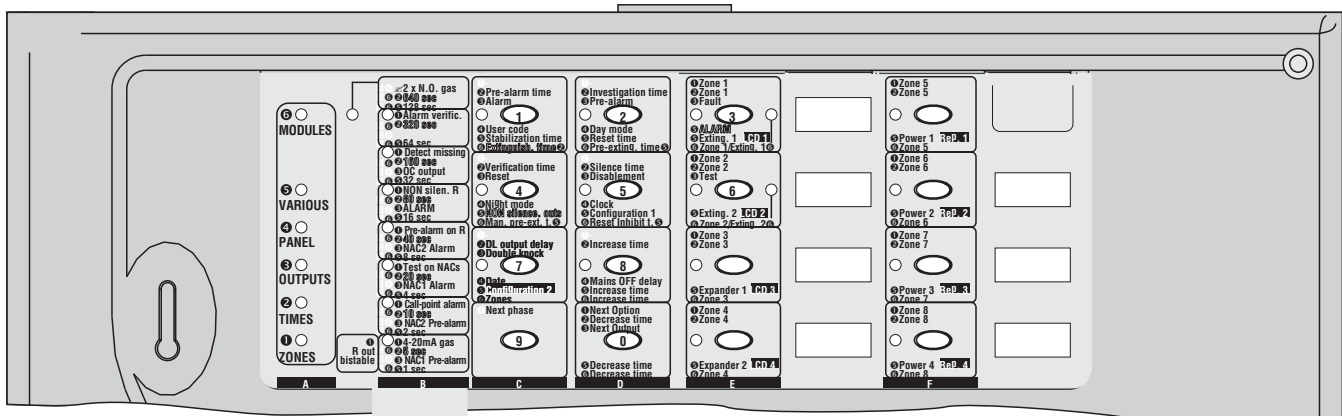

Figure 29 Using the Programming Overlay with a J408 Control panel

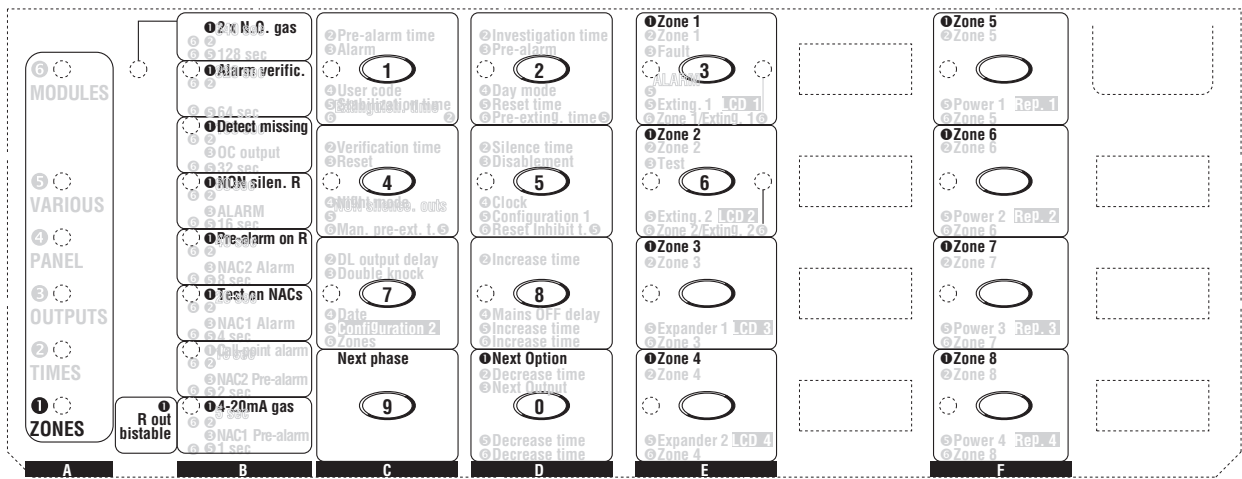

Figure 30 Programming the Zones

The “ZONES” Programming Phase

The **ZONES** LED will blink to indicate that the system is ready to start the programming procedure. During this phase, the keys and LEDs will operate in accordance with the options preceded by ❶ in the panes on the Programming Overlay, see Figure 30.

The meaning of the first LED at the bottom of column B is “R Output Bistable” for the zones in which the option “Double N.O. Gas” is enabled.

1. Using the **Next option** key (0 column D), select the option you want to program. The respective LED will go On (see column B).
2. Using the key of the zone concerned (Z1 ... Z24), enable/disable the selected option: – if the respective zone LED is On, the selected option is enabled; – if the respective zone LED is Off, the selected option is disabled.
3. Go back to step 1 to program another zone option **or**, press the **Next phase** key 9 to go to the following Programming Phase (see column A).

The “TIMES” Programming Phase

The **TIMES** LED will blink to indicate that the system is ready to start the programming procedure. During this phase, the keys and LEDs will operate in accordance with the options preceded by ❷ in the panes on the Programming Overlay, see Figure 31.

1. Using the keys in columns C and D, select the Time option you want to program.
2. Using the **Increase Time** option (Key 8), or the **Decrease Time** option (Key 0), respectively increase or decrease the setting. The setting is achieved by adding together the values indicated by the LEDs in column B (e.g. if the 40 sec and 20 sec LEDs are On, the setting will be 60 seconds).
3. If you want to program the **Verification time** or **Silence Time** or the **DL output delay**, go to step 4. If you want to save the setting, press the key of the zone concerned (Z1 ... Z24): – if the respective LED is On, the new Time setting has been saved; – if the respective LED is Off, the new Time setting has not been saved (setting unchanged).
4. Go back to step 1 to program another Time option **or**, press the **Next phase** key 9 to go to the following Programming Phase (**Outputs** — column A).

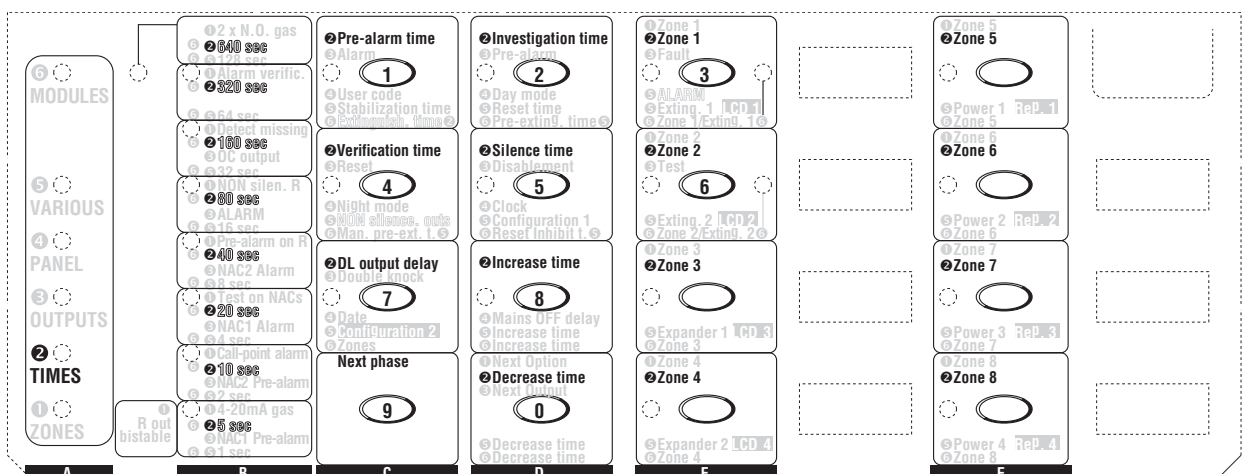

Figure 31 The “Times” Programming Phase

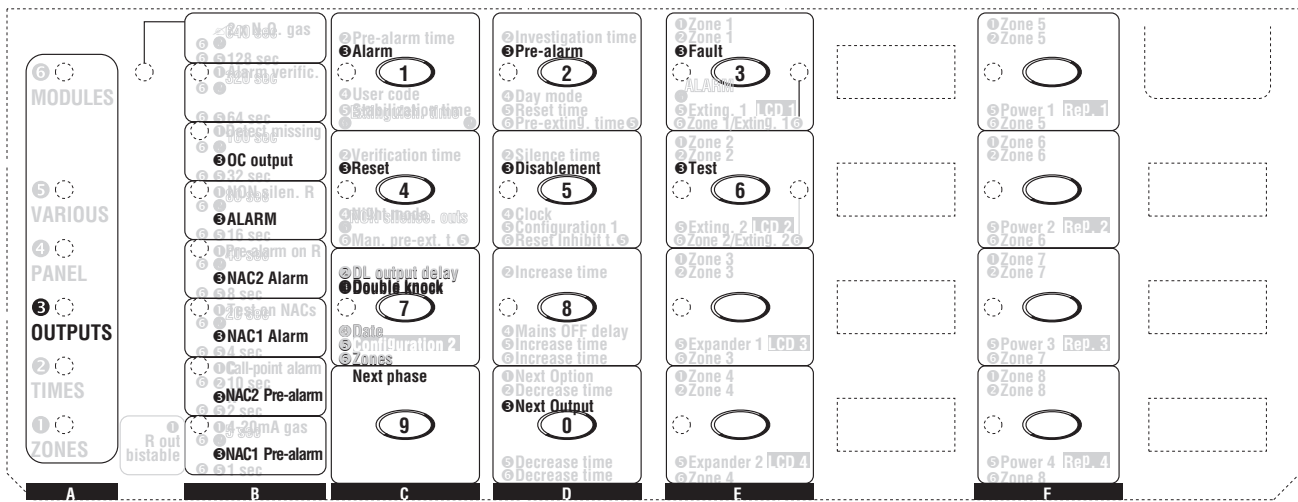

Figure 32 The “Outputs” Programming Phase

The “OUTPUTS” Programming Phase

The **OUTPUTS** LED will blink to indicate that the system is ready to configure the Output Pulse Pattern (represented by LEDs 1 through 8, each LED representing a second period in the pattern). During this phase, the keys and LEDs will operate in accordance with the options preceded by ④ in the panes on the Programming Overlay, see Figure 32.

- Using the **Next Output** key (0 column D) select the output you want to program. The respective LED will go On (see column B).
- If you are programming the **OC Output**, go to step 3. If you are programming the NAC 1, NAC 2 or ALARM outputs, the pattern is achieved by using Keys 1 through 8, as follows: – if the LED is On, the output will be On for the corresponding 1 second period in the pattern; – if the LED is Off, the output will be Off for the corresponding 1 second period in the pattern. For example, LEDs 1 through 4 On and 5 through 8 Off indicates 4 seconds On and 4 seconds Off, all LEDs On indicates continuously On.

- Using keys 1 through 7, select or deselect the OC Output events:
 - if the LED is On, the OC Output will signal the respective event;
 - if the LED is Off, the OC Output will not signal the respective event.
- Go back to step 1 to program another Output option or, press the **Next phase** key 9 to go to the following Programming Phase (see Column A).

The “PANEL” Programming Phase

The **PANEL** LED will blink to indicate that the system is ready to program the **User Code**, **Day** and **Night Mode** Times and current **Time** and **Date**. During this phase, the keys and LEDs will operate in accordance with the options preceded by ④ in the panes on the Programming Overlay, see Figure 33.

- Using the keys in columns C and D, select the parameter you want to program (refer to the respective paragraph for details) **or**, press the **Next phase** key 9 to go to the following Programming Phase (see Column A).

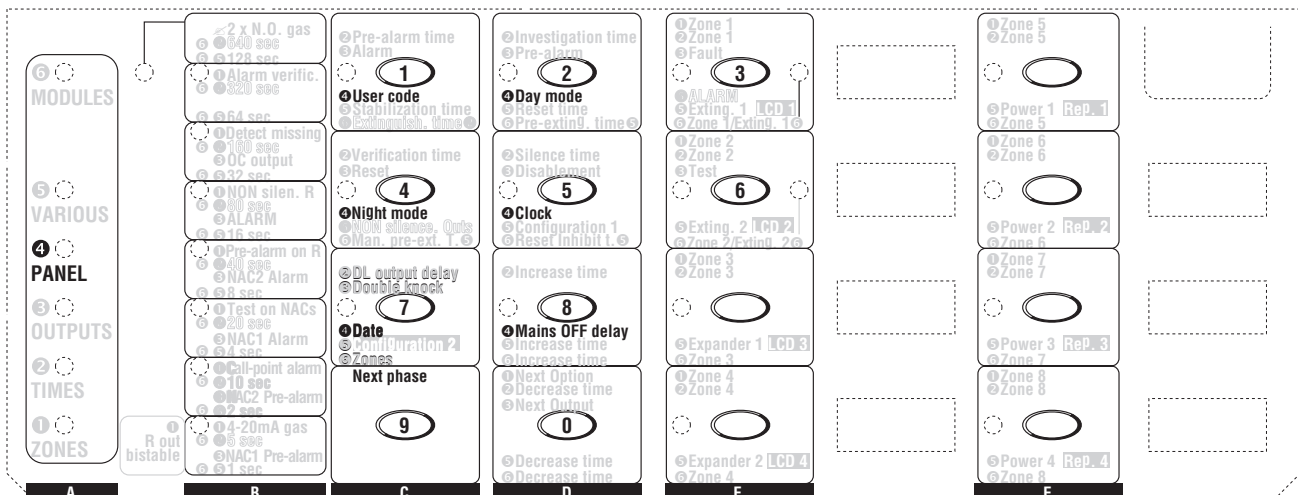

Figure 33 The “Panel” Programming Phase

■ **User Code (Key/LED 1)**

The LED will go On to indicate that the system is ready to start the programming procedure. Using keys 0 through 9, type in a 4 digit User Code. The LED will go Off after entry of the fourth digit (indicating that the “User Code” has been accepted).

■ **Day Mode (Key/LED 2)**

The LED will go On to indicate that the system is ready to start the programming procedure. Using keys 0 through 9, type in the “Time” when the changeover from **Night** to **Day** Mode must occur. Enter two digits for the Hour (00 to 23 — 00 for Midnight) and two for the Minutes (00 to 59). The LED will go Off after entry of the fourth digit (indicating that the setting has been accepted).

■ **Night Mode (Key/LED 4)**

The LED will go On to indicate that the system is ready to start the programming procedure. Using keys 0 through 9, type in the “Time” (formatted as per Day Mode) when the changeover from **Day** to **Night** Mode must occur. The LED will go Off after entry of the fourth digit (indicating that the setting has been accepted).

■ **Clock (Key/LED 5)**

The LED will go On to indicate that the system is ready to start the programming procedure. Using keys 0 through 9, type in the current “Time” (format as per **Day Mode**).

■ **Date (Key/LED 7)**

The LED will go On to indicate that the system is ready to start the programming procedure. Using keys 0 through 9, enter the respective two digits for the Day (00 to 31), Month (00 to 12) and Year (00 to 99). The LED will go Off after entry of the last digit (indicating that the setting has been accepted). Wrong entries will be signalled by an audible error signal.

■ **Mains Off Delay (Key/LED 8)**

The LED will go On to indicate that the system is ready to start the programming procedure. Using keys 0 through 9, type in the length of time the Control panel must wait before signalling a Mains Failure event. Enter two digits (0 through 30 minutes). The LED will go Off after entry of the second digit (indicating that the “Mains Off

Delay” has been accepted). Wrong entries will be signalled by an audible error signal.

The “VARIOUS” Programming Phase

The **VARIOUS** LED will blink to indicate that the system is ready to program the **Stabilization Time, Reset Time, Silenceable Outs** and **Configuration 1 and 2**. During this phase, the keys and LEDs will operate in accordance with the options preceded by 5 in the panes on the Programming Overlay, see Figure 34.

- Using the keys in columns **C** and **D**, select the parameter you want to program, then refer to the respective paragraph **or**, press the **Next phase** key **9** to go to the following Programming Phase (see Column **A**).

■ **Stabilization Time (Key/LED 1)**

The LED will go On to indicate that the system is ready to start the programming procedure. Use the **Increase Time** option (Key **8**) or **Decrease Time** option (Key **0**), respectively, to increase or decrease the setting. The setting is achieved by adding together the values indicated by the LEDs in column **B** (e.g. if the **8 sec** and **2 sec** LEDs are On, the setting will be 10 seconds).

■ **Reset Time (Key/LED 2)**

The LED will go On to indicate that the system is ready to start the programming procedure. This setting is achieved and formatted as per the Stabilization Time.

■ **Non-Silenceable Outs (Key/LED 4)**

Press key 4 (NON-Silence. Outputs) to set the NON-Silenceable Outputs, then press key 3 (ALARM) to set the ALARM Output as NON-Silenceable.

- if the **ALARM** LED is On, the ALARM Output is NOT Silenceable;
- if the **ALARM** LED is Off, the ALARM Output is Silenceable.

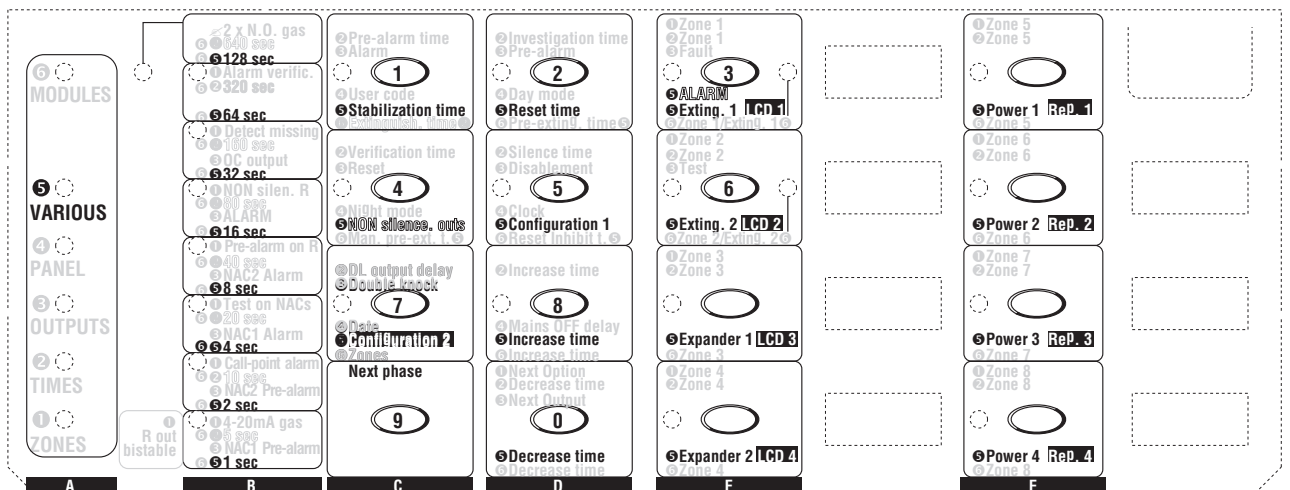

Figure 34 The “VARIOUS” Programming Phase

■ Configuration 1 (Key/LED 5)

The LED will go On to indicate that the system is ready to start the programming procedure. Using the keys in columns **E** and **F**, configure the Control panel:

- if the LED is On, the respective Module is included in the configuration;
- if the LED is Off, the respective Module is NOT included in the configuration.

During this phase, the keys and LEDs in columns **E** and **F** will operate in accordance with the options written in *positive type*:

- **Exting. 1** = Extinguishment Module nr. 1
- **Exting. 2** = Extinguishment Module nr. 2
- **Expander 1** = Expander Module nr. 1
- **Expander 2** = Expander Module nr. 2
- **Power 1** = Power Station nr. 1
- **Power 2** = Power Station nr. 2
- **Power 3** = Power Station nr. 3
- **Power 4** = Power Station nr. 4

■ Configuration 2 (Key/LED 7)

The LED will go On to indicate that the system is ready to start the programming procedure. Using the keys in columns **E** and **F**, configure the Control panel:

- if the LED is On, the respective Module is included in the configuration;
- if the LED is Off, the respective Module is NOT included in the configuration.

During this phase, the keys and LEDs in columns **E** and **F** will operate in accordance with the options written in *negative type*:

- **LCD 1** = LCD Module nr. 1
- **LCD 2** = LCD Module nr. 2
- **LCD 3** = LCD Module nr. 3
- **LCD 4** = LCD Module nr. 4
- **Rep. 1** = Repeater panel nr. 1
- **Rep. 2** = Repeater panel nr. 2
- **Rep. 3** = Repeater panel nr. 3
- **Rep. 4** = Repeater panel nr. 4

The “MODULES” Programming Phase

The Activation Mode may ONLY be programmed THROUGH A PC.

The **MODULES** LED will blink to indicate that the system is ready to program the parameters of the Extinguishment Modules. During this phase, the keys and LEDs will operate in accordance with the options preceded by ⑥ in the panes on the Programming Overlay, see Figure 35.

The LED (**Exting. 1** or **Exting. 2**) corresponding to the Extinguishment Module concerned will blink to indicate that the system is ready to program the respective parameters. Press key **1** (**Extinguish. Time**), **2** (**Pre-Exting. Time**), **4** (**Man. pre-Ext. T.**), **5** (**Reset Inhibit T.**) or **7** (**Zones**) to select the parameter to be programmed, then read the relevant sub-section, or press key **9** (**Next Phase**) to go back to the ZONE Programming.

■ Extinguish. time (Key/LED 1)

The LED will go On to indicate that the system is ready to start the programming procedure.

Use the **Increase Time** option (Key **8**) or **Decrease Time** option (Key **0**), respectively, to increase or decrease the setting. The setting is achieved by adding together the values preceded by ⑥ and ②, indicated by the LEDs in column **B** (e.g. if the **20 sec** and **40 sec** LEDs are On, the setting will be 60 seconds (20+40)).

■ Pre-exting. time (Key/LED 2)

The LED will go On to indicate that the system is ready to start the programming procedure.

Use the **Increase Time** option (Key **8**) or **Decrease Time** option (Key **0**), respectively, to increase or decrease the setting. The setting is achieved by adding together the values preceded by ⑥ and ⑤, indicated by the LEDs in column **B** (e.g. if the **16 sec** and **4 sec** LEDs are On, the setting will be 20 seconds (16+4)).

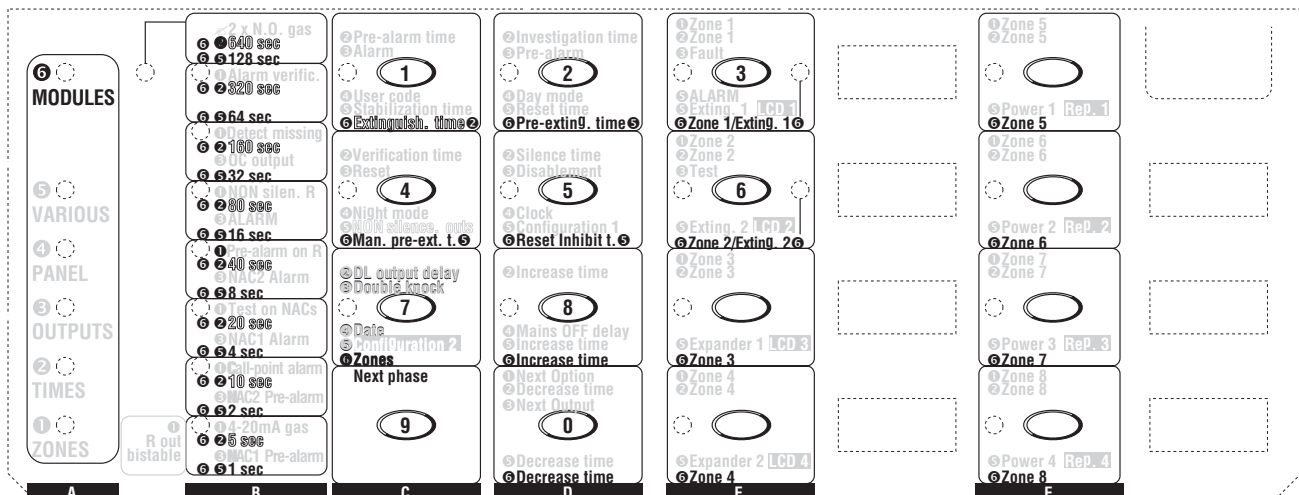

Figure 35 The “Modules” Programming Phase

■ Man. Preest-Ex. T. (Key/LED 4)

The LED will go On to indicate that the system is ready to start the programming procedure.

Use the **Increase Time** option (Key 8) or **Decrease Time** option (Key 0), respectively, to increase or decrease the setting. The setting is achieved by adding together the values preceded by ⑥ and ④, indicated by the LEDs in column B (e.g. if the 16 sec and 4 sec LEDs are On, the setting will be 20 seconds (16+4)).

■ Reset Inhibit T. (Key/LED 5)

The LED will go On to indicate that the system is ready to start the programming procedure.

Use the **Increase Time** option (Key 8) or **Decrease Time** option (Key 0), respectively, to increase or decrease the setting. The setting is achieved by adding together the values preceded by ⑥ and ④, indicated by the LEDs in column B (e.g. if the 16 sec and 4 sec LEDs are On, the setting will be 20 seconds (16+4)).

■ Zones (Key/LED 7)

The LED will go On to indicate that the system is ready to start the programming procedure.

Using the Zone keys (Z1 to Z 8 for the J408; Z1 to Z 24 for the J424) ENABLE/DISABLE the respective Zones for “Activation” of the Extinguishment Module concerned:

- if the respective Zone LED is On, the Zone will trigger activation of the Extinguishment Module concerned;
- if the respective Zone LED is Off, the Zone will NOT trigger activation of the Extinguishment Module concerned.

LCD Module

The LCD Module will allow you to program the following parameters from a J424 Control panel or from a J400-REP Repeater panel:

- LCD Module Address
- Zone Descriptions
- Strings Update

Date Format

To access the programming phase, insert the LCD Module jumper 82, the module will provide the Main menu.

■ Programming Mode Address

Program this option as follows.

1. Using ▼ or ▲, select the **Programming Mode Address** option:

```
PROGRAMMING MODE
ADDRESS : 1
```

2. Using ► or ◀, assign the respective Address to the LCD Module.

```
PROGRAMMING MODE
ADDRESS : 4
```

☞ *If you are using an LCD Module with a J424, assign Address 4. If you are using an LCD Module with a Repeater panel, assign the Repeater panel Address.*

■ Zones Descriptions

1. Using ▼ or ▲, select Zones Descriptions:

```
ZONE DESCRIPTION
press ENTER
```

2. Press **Enter**:

```
ZONE 1
Zone 1
```

3. Using ► or ◀, select the character you want to change (the selected character will blink).
Using ▼ or ▲, select the new character.

```
ZONE 1
Warehouse
```

4. Press **Enter** to save the Description on the screen and step back **or**, press **Esc** to save the Description on the screen and go back to the Main Menu.

☞ *Any changes made to the Descriptions — via the LCD Module — must be broadcasted to the other Modules by means of the **Strings Update** command.*

■ Strings Update

1. Using ▼ or ▲, select **Update Strings**.

```
STRINGS UPDATE
press ENTER
```

2. Press **Enter** to update the Descriptions.

```
UPDATE
EXECUTED
```

3. Press **Esc** to go back to the Main Menu..

■ Date Format

1. Using ▼ or ▲, select Date Format:

```
DATE FORMAT :
dd/mm/yyyy
```

2. Using ► or ◀, select the date format:
 - **dd/mm/yyyy** = day/month/year;
 - **mm/dd/yyyy** = month/day/year.

```
DATE FORMAT :
mm/dd/yyyy
```

3. Press **Enter** or **Esc** to confirm and go back to the Main menu.

This quick guide is for installers with knowledge of the J424 and J408 control panels, and fire control panels in general. This chapter holds all the necessary installation details.

Technical features

Some of the technical features, regarding the terminals on the Main and Expander boards, are described in the following paragraph.

CONTROL PANEL	J424	J408
Main voltage	230 V \sim 50 Hz -15/+10%	
Maximum current	0.9 A	0.5 A
Power	60 W	35 W
Maximum current available...(1)	1.5 A	1 A
Low voltage range	19.0 ÷ 27.6 V	
Minimum output voltage	19,0 V \pm 5 %	
Low voltage ripple	1 %	
Suitable batteries: make model	2 * 12 V/17 Ah YUASA NP 17-12 FR or equivalent with case flame class UL94-V2 or higher	2 * 12 V/7 Ah YUASA NP 7-12 FR or equivalent with case flame class UL94-V2 or higher
Maximum internal resistance of the battery and associated circuitry	1 Ω	
Temperature range	-5 ÷ +40 °C	
Dimensions (W*H*D)	422*502*116 mm	354*280*100 mm
Weight	18.7 Kg(2)	8.2 Kg(3)

(1) ... for the power supply of the optional modules (Extinguishment modules, Expander modules e Display module) and external devices.

(2) With two 12 V, 17 Ah batteries, 2 Expander modules, 2 Extinguishment modules and the Display module.

(3) With two 12 V, 7 Ah batteries and 1 Extinguishment module.

The following Table shows the current draw of the Control panel modules.

MODULE	CURRENT DRAW (A)	
	in Standby	maximum
Main Board+J408-2 2-Zone Control Board	0.08	0.25
Main Board+J408-4 4-Zone Control Board	0.1	0.27
Main Board+J408-8 and J424 8-Zone Control Board	0.13	0.3
J400-EXT Extinguishment Module	0.04	0.21
J400-EXP8 Expander Module	0.06	0.5
J400-LCD Module	0.08	0.08

Description of the terminals

The terminals of the 8 zone Main board, 4/2 zone Main boards, Expander board, Extinguishment board and Switching power supply, are described briefly in the a Table 4: the standby (normal) status is the first, followed by the alarm status. Moreover, the Voltage present during the different operating conditions is indicated for each terminal, as well as the

TERM.	DESCRIPTION	v(V)	i(A)
MAIN BOARD and EXPANDER BOARD			
[Z1] ↓ [Z8] (5)	Supervised and Bypassable DETECTION ZONE: Negative pull-down on terminal to 0 V with 3900 ohm → respective zone in Standby Negative pull-down on terminal to 0 V with 680 ohm → respective zone in Auto- Alarm Negative pull-down on terminal to 0 V with 270 ohm → respective zone in Manual Alarm terminal shorted or open → fault signalling	27.6	0.06 (4)
[+]	DETECTOR NEGATIVE	0	—
[R1] ↓ [R8]	Silenceable ZONE ALARM REPEAT: respective zone in standby status → terminal open respective zone in alarm → Negative pull-down to 0 V on terminal	0	0.1

Table 4 Description of terminals (Continues ...)

maximum current (in amps) that can circulate:

TERM.	DESCRIPTION	v(V)	i(A)
2 and 4 ZONE MAIN BOARDS			
[DL] (5)	Supervised—Bypassable DIALLER Output during Standby → floating on expiry of the Alarm Signalling Delay → negative pull-down to 0 V	0	0.1
[OC]	PROGRAMMABLE AUXILIARY Output: during Standby → terminal floating on verification of an associated event → negative pull-down to 0 V	0	1
[24V] [↗]	24 V POWER Output: Positive pull-up to 27.6 V on [24V] terminal Negative pull-down to 0 V on [↗] terminal	27.6 0	1(4) —
[24R] [↗]	RESETTABLE 24 V POWER Output: during Standby → positive pull-up to 27.6 V on [24R] terminal during Reset → [24R] terminal floating; Negative pull down to 0 V on [↗] terminal	27.6 — 0	1(4) — —
[PL]	POWER LOSS Output: during Standby → floating during power failure → negative pull-down to 0 V	— 0	— 1
ALARM	Non-Supervised—Silenceable ALARM Output: Control panel in Standby → [COM] terminal connects to [NC] and [NO] floats Control panel in Alarm → the [COM] and [NO] terminals connect, in accordance with programming	—	5
FAULT	Non-Supervised—Silenceable—Bypassable FAULT Output: Control panel in Standby → [COM] terminal connects to [NC] and [NO] floats in the event of Fault → [COM] terminal connects to NO] and [NC] floats	—	5
NAC1 (6)	Supervised—Silenceable—Bypassable ALARM Output N. 1: Panel in Standby → negative pull-down to 0 V on [+] terminal; positive pull-up to 27.6 on [-] terminal Panel in Alarm → positive pull-up to 27.6 on [+] terminal; negative pull-down to 0 V on [-] terminal	27.6	1(4)
NAC2 (6)	Supervised—Silenceable—Bypassable ALARM Output N. 2: Panel in Standby → negative pull-down to 0 V on [+] terminal; positive pull-up to 27.6 V on [-] terminal Panel in Alarm → positive pull-up to 27.6 on [+] terminal; negative pull down to 0 V on [-] terminal	27.6	1(4)
8 ZONE MAIN BOARD			
RS485	RS485 Serial Port: Positive pull-up to 27.6 V on [24V] terminal; Negative pull-down to 0 V on [↗] terminal; data on [+] and [-] terminals	27.6 0 —	1(4) — —

Table 4 (...continued) *Terminals Description*

(4) The sum of the currents absorbed by terminals [Z1], [Z2], ..., [Z8], [24V], [24R], [NAC1] and [NAC2] must not exceed: 1.5 A for the J424 control panel; 1 A for the J408 control panel.

(5) The terminals [Z1], [Z2], ..., [Z8] and [DL], if not used, must be connected to negative using a 3900 ohm resistor.

(6) Connect a 3900 ohm resistor between the [+] and [-] terminals of the NAC1 and NAC2 Outputs, if not used.

EXTINGUISHMENT BOARD			
EM	Supervised—Bypassable MANUAL EXTINGUISHMENT Input 3.900 ohm (680 ohm se NC) across [+] and [-] terminals → Input in Standby 680 ohm (3.900 ohm se NC) across [+] and [-] terminals → PRE-EXTINGUISHMENT time [+] and [-] terminals shorted or open → Manual Extinguishment Fault signalling	—	—
IE	Supervised INHIBIT EXTINGUISHMENT Input : 3.900 ohm (680 ohm if NC) across [+] and [-] → Input in Standby 680 ohm (3.900 ohm if NC) across [+] and [-] terminals → EXTINGUISHMENT impossible [+] and [-] terminals shorted or open → Inhibit Exting. Fault signalling	—	—
PS	Supervised PRESSURE SWITCH Input : 3.900 ohm (680 ohm if NC) across [+] and [-] terminals → Input in Standby 680 ohm (3.900 ohm if NC) across [+] and [-] terminals → Pressure Switch Activated signalling [+] and [-] terminals shorted or open → Pressure Switch Fault signalling	—	—
[EV]	Supervised ELECTROVALVE Output : Extinguishment Module in Standby → terminals disconnected Extinguishment Module in Extinguishment phase → terminals connected terminals shorted or open → Electrovalve Fault signalling	—	5
24P	POWER BOOST Input : Power supply Input for the PR and AE Outputs	—	—
PR	Supervised PRE-EXTINGUISHMENT Output : Extinguishment Module in Stand by → negative on [+] terminal, positive on [-] terminal during the Pre-Extinguishment phase → positive on [+] terminal, negative on [-] terminal terminals [+] and [-] shorted or open → Fault Pre Ext. signalling	-27.6 27.6	— 1
AE	ACTIVATED EXTINGUISHMENT Output : Extinguishment Module in Stand by → negative on [+] terminal, positive on [-] terminal during the Extinguishment phase → positive on [+] terminal, negative on [-] terminal	-27.6 27.6	— 1
PE	POSTPONE EXTINGUISHMENT Output : IE Input in standby → suspended terminal IE Input activated → terminal connected to negative	0	— 0.1

Table 4 (...continued) *Terminals Description*



BENTEL SECURITY s.r.l.
Via Gabbiano, 22 – Zona Ind. S. Scolastica
64013 Corropoli (TE) - ITALY
Tel.: +39 0861 839060
Fax: +39 0861 839065
e-mail: info@bentelsecurity.com
<http://www.bentelsecurity.com>

ISTISBLEJ408-8 2.0 090709 V10